

DLM5000HD **DLM3000HD**

Precision in Every Detail

DLM Series

High Definition Oscilloscope/Mixed Signal Oscilloscope



Precision Making

Bulletin DLM-Series-01EN

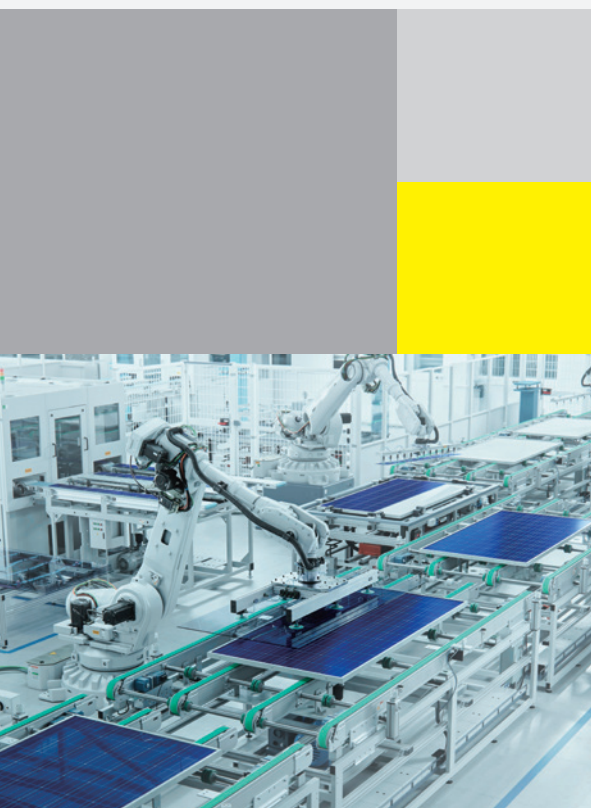

Yokogawa's DLM series of oscilloscopes represents cutting-edge innovation, drawing on over a century of expertise in measuring instrument technology. The DLM series includes a variety of models, from unique vertical compact 2- and 4-channel options to 8-channel benchtop models. The operation panel, equipped with a highly responsive touch screen, keys, and knobs, ensures intuitive control of various analysis functions while maintaining familiar operability. Notably, this oscilloscope is the industry's first to feature a serial bus auto setup function, which automatically configures analysis tools for diverse in-vehicle network protocols, making it indispensable for engineers and researchers in the automotive sector. The DLM series from Yokogawa is set to elevate your development and evaluation processes to new heights.

Effortless – A series of lightweight, compact oscilloscopes designed for high-resolution observation and analysis of complex, high-speed waveforms. Easily detects minute noise, ringing, and other issues and the intuitive touchscreen, auto setup, and extensive analysis functions streamline complex diagnostics, delivering unparalleled testing precision.

Harmonizing – The DLMsync function, enables a seamless measurement environment of up to 16 channels by connecting two units. It addresses customer needs for correlating power data with various waveforms, allowing time synchronization with power analyzers and other measuring instruments.

Reliable – Catering for a wide array of applications, from circuit checks and troubleshooting to advanced timing analysis. With its dedicated operating system and rapid response time, engineers can trust their daily measurements, ensuring quick and secure operation.



1.6 MHz
POWER SUPPLY SWITCHING FREQUENCY

0.35 WATT
POWER LOSS



500 kbps
CAN BUS BIT RATE

145 H
CAN IDENTIFIER

19.2 kbps
CXPI BUS BIT RATE

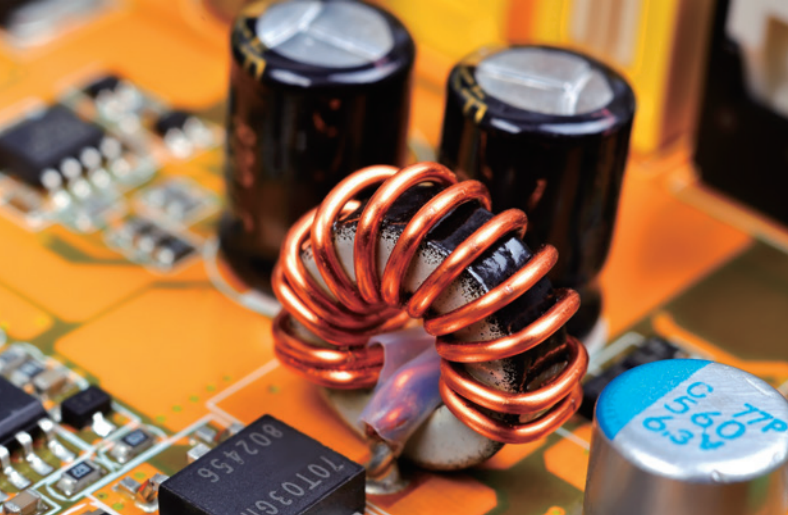
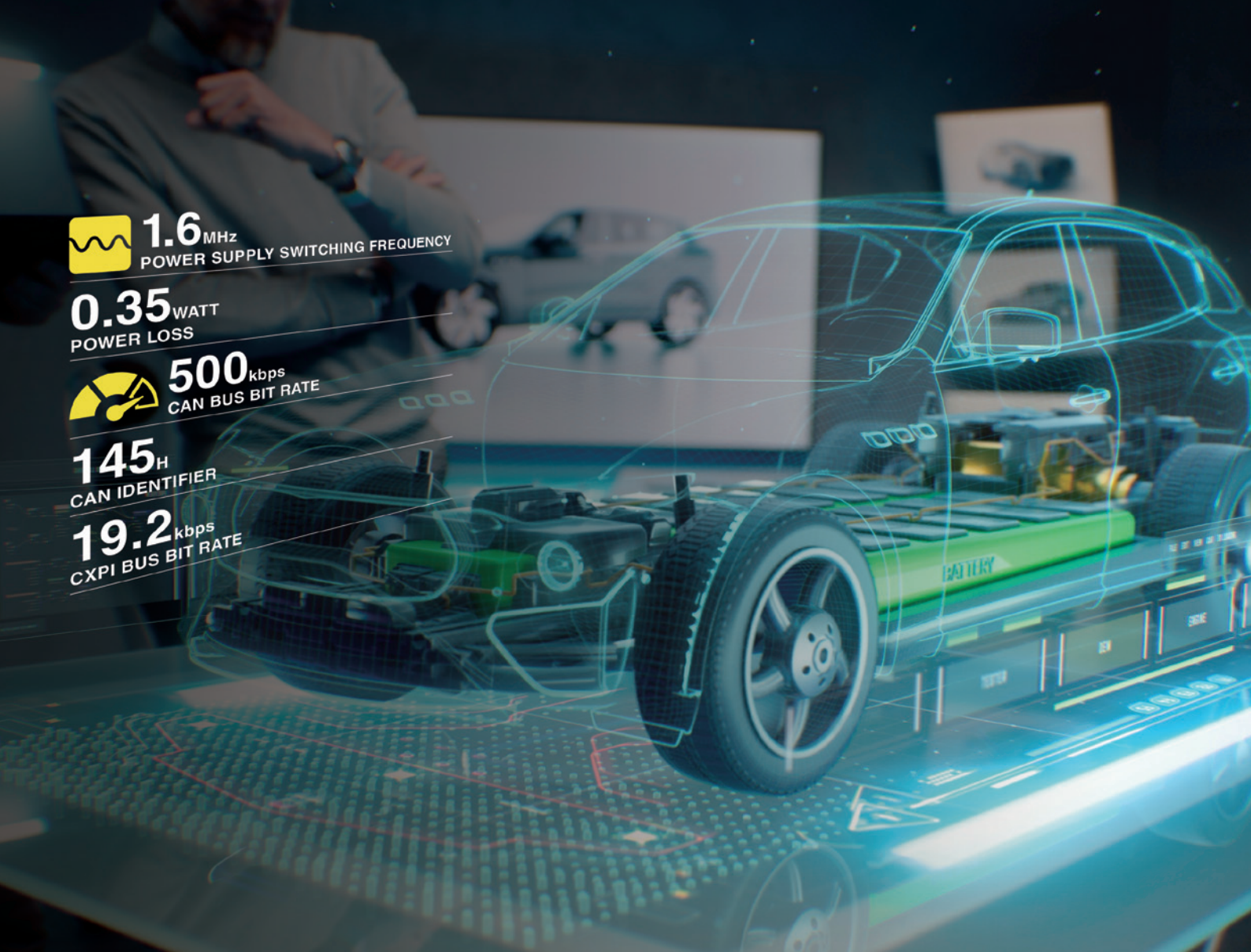



Meet the new standard of high-definition oscilloscope

One Gpoints-long memory

The memory size of a measuring instrument is directly related to the measurement time. Equipped with a long, 1 G point memory, the DLM5000HD/DLM3000HD can record multiple channels at once, greatly increasing work efficiency.

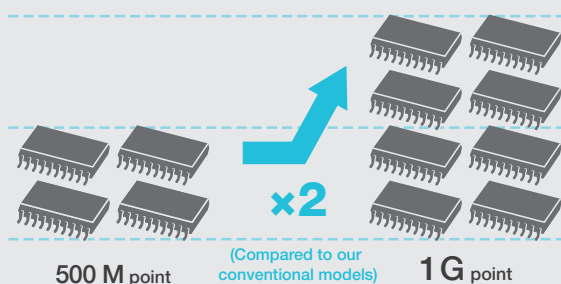

Superior noise immunity

The DLM series is designed to be resistant to noise and its touch panel is less likely to malfunction even in highly noisy environments. The touch panel can be disabled so that the DLM series is operated using just the buttons.

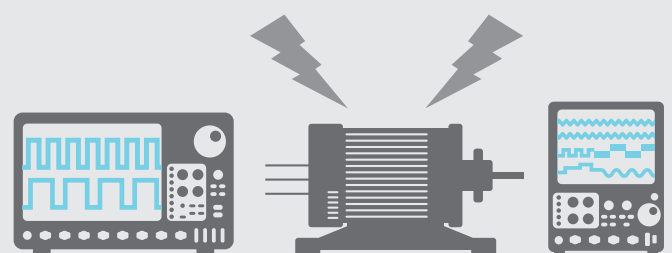



NEW!

“16x”

more detailed measurements than a conventional MSO

- ✓ Best-in-class startup speed for superior usability
- ✓ High noise immunity allows operation even in harsh environments
- ✓ Never miss a measurement target
High performance in the mid-range segment
 - Frequency bandwidth: 500 MHz*
 - Sample rate: 2.5 G sample/second*
 - Vertical axis resolution: 12 bit
 - Measurement memory: 1 G points* *Max. value
- ✓ Easy two-unit synchronization at the touch of a button

Cover a wide measurement range with 12 bits

The DLM5000HD/DLM3000HD accurately captures waveform overshoot and ringing to enable more accurate measurements than ever before.

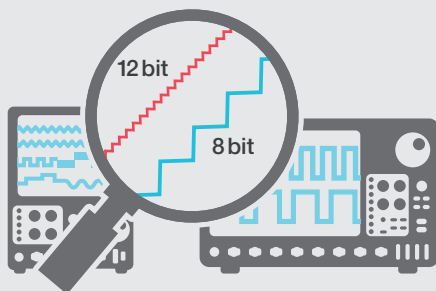

Easy to carry and measures quickly



DLM5000HD
DLM5000

180 mm

Modest 180 mm depth
7.3 kg portable design



DLM3000HD
DLM3000

193 mm

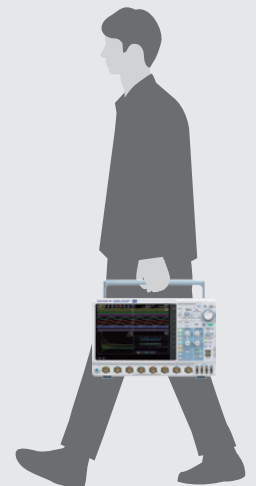

YOKOGAWA's Oscilloscopes

YOKOGAWA DLM series oscilloscopes offer a wide variety of parameter measurement, statistics, and real-time math functions. With a thoughtfully designed, user-friendly user interface and various analysis functions, the DLM series provides total support for the measurements you need to make and greatly increases your productivity.

Choose from 4 models to suit your application



NEW!

12 bit ADC



NEW!

12 bit ADC

	DLM5000HD series	DLM3000HD series
Frequency bandwidth (-3 dB)	350 MHz/500 MHz	
Maximum channels	4 analog channels + 32 logic channels (4-ch model) 8 analog channels + 32 logic channels (8-ch model)	4 analog channels or 3 analog channels + 8 logic channels (4-ch model)
Vertical axis resolution	12 bit (16 bit High Resolution mode available)	
Memory size	1 Gpoint	
Number of history waveforms	200000	
Two-unit synchronous connection function (DLMsync)	Yes (Option)	
IEEE1588 synchronous support		
Slave function	Yes	
Master function	Yes (Option)	

8 channel
Oscilloscope



Digital Oscilloscope

DL5180
1993



Digital Oscilloscope

DL2700
1996



Digital Oscilloscope

DL7480
2002

Portrait style
Oscilloscope

1989



Digital Oscilloscope
DL1200

1995



Digital Oscilloscope
DL1540



Digital Oscilloscope
DL1740
2000



Digital Oscilloscope
DL1640

2002

YOKOGAWA's Oscilloscope Timeline



	DLM5000 series	DLM3000 series
Frequency bandwidth (-3 dB)	350 MHz/500 MHz	200 MHz/350 MHz/500 MHz
Maximum channels	4 analog channels + 32 logic channels (4-ch model) 8 analog channels + 32 logic channels (8-ch model)	4 analog channels or 3 analog channels + 8 logic channels (4-ch model)
Vertical axis resolution	8 bit (12 bit High Resolution mode available)	
Memory size	500 Mpoint	
Number of history waveforms	100000	
Two-unit synchronous connection function (DLMSync)	Yes (Option)	No
IEEE1588 synchronous support		
Slave function	Yes	No
Master function	No	

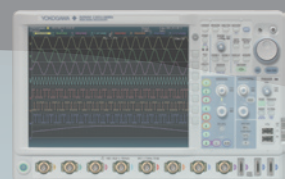

Mixed Signal Oscilloscope
DLM4000
2012

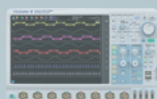

Mixed Signal Oscilloscope
DLM5000
2020



High Definition Oscilloscope
DLM5000HD Series

2023



High Definition Oscilloscope
DLM3000HD Series

2024



Mixed Signal Oscilloscope
DLM2000
2008



Mixed Signal Oscilloscope
DLM3000
2018

Advantages and Features

12-bit high resolution **NEW!** Supported models [DLM5000HD](#) [DLM3000HD](#)

A 12-bit measuring instrument is effective in accurately measuring events such as ringing after overshoot. Optimal range settings can be made to capture minute changes accurately while checking the whole image of the waveform.

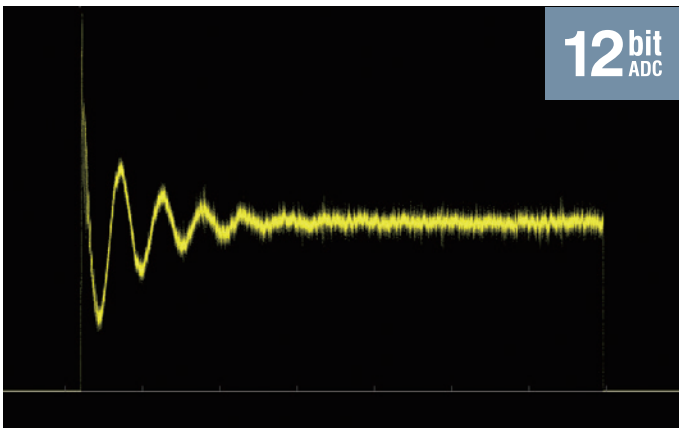

At 12 bit

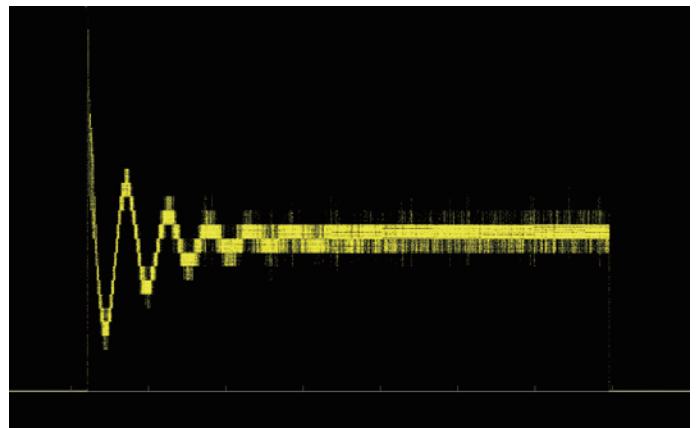

At 8 bit

Up to 2.5 GS/s (eight channels at once) and up to 1 G points-long memory **NEW!**

Supported models [DLM5000HD](#) [DLM3000HD](#)

The DLM5000HD/DLM3000HD are equipped with a memory that can capture up to 1 G points (odd channels only) in a single waveform and up to 125 M points in a repetitive waveform acquisition, enabling long time measurement without reducing the sample rate.

[Basic Formula] **Measuring time = Record length/Sample rate**

Relationship between measuring time and sample rate in 1 Gpoint

Sample rate	Maximum measuring time
2.5 GS/s	0.4 s
250 MS/s	4 s
25 MS/s	40 s
2.5 MS/s	400 s
250 kS/s	4000 s
100 kS/s	10000 s

Sample rate is too low.

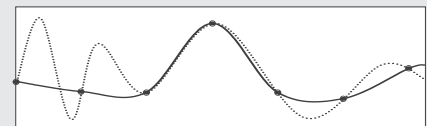

Sample rate is fairly high.



More memory is needed to use higher sample rates and capture the most accurate waveform representation.

Useful history function Supported models **DLM5000HD** **DLM3000HD** **DLM5000** **DLM3000**

Automatically save previously captured waveforms

With the DLM series, up to 200000 previously captured waveforms can be saved in the acquisition memory. With the History function, you can display just one or all of the previously captured waveforms (history waveforms) on screen. You can also perform cursor measurement, computation, and other operations on history waveforms. Using the History function, you can analyze rarely-occurring abnormal signals even when an appropriate trigger condition is hard to find because its waveform shapes are not constant.

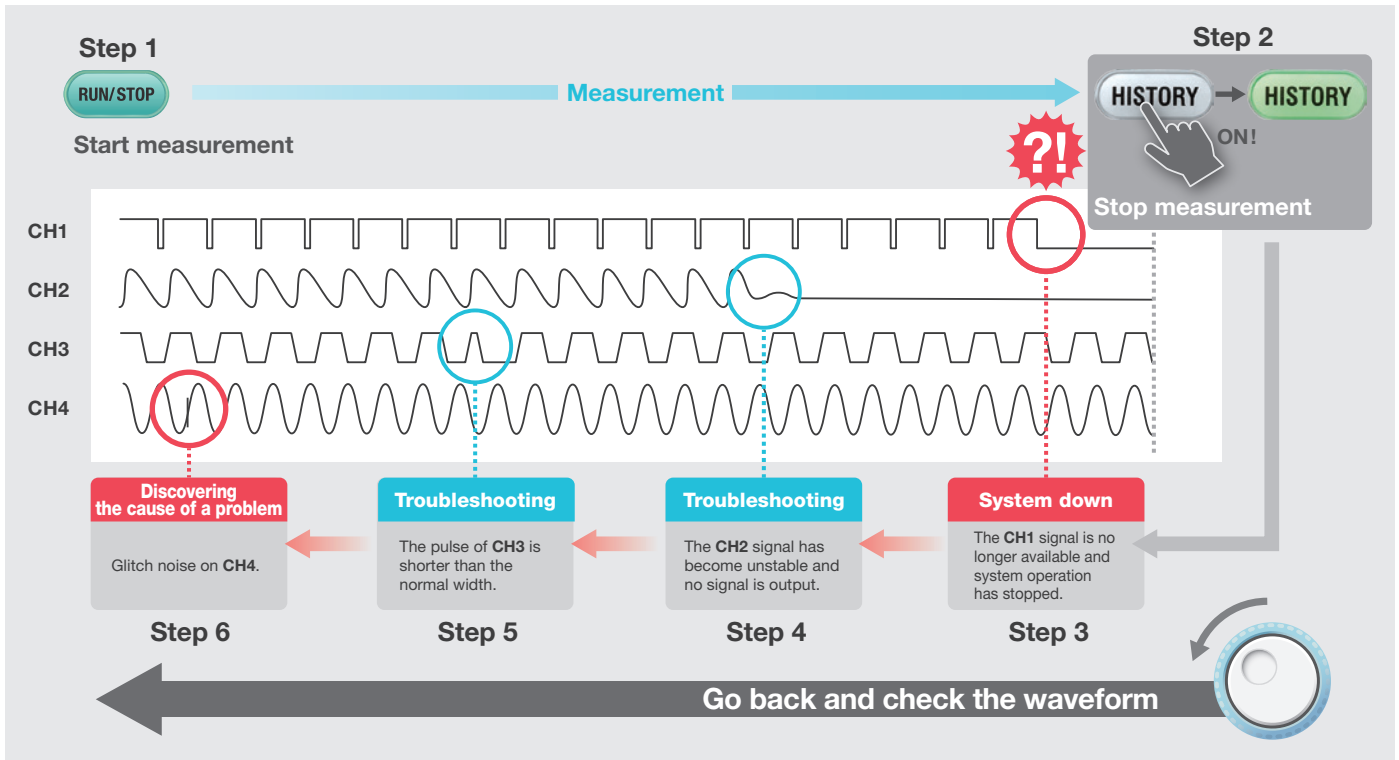

History search function

Supported models **DLM5000HD** **DLM3000HD** **DLM5000** **DLM3000**

Multiple powerful search methods are available to search up to 200000 waveforms* for events meeting your custom requirements. Intuitive and simple waveform search functions are provided. For example, you can specify a rectangular zone that captures a part of a waveform on the screen, a zone that covers an entire measured waveform, or a polygonal zone. If you know a value of interest, such as an abnormal value of voltage or pulse width, you can search history waveforms using waveform parameters.

*Up to 100000 for DLM5000/DLM3000

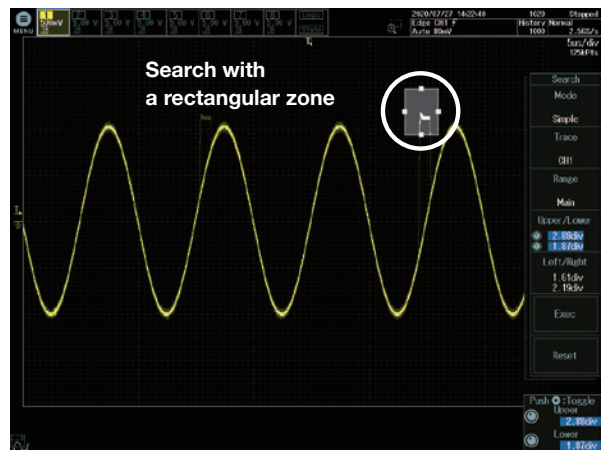

RectZone

DLMsync two-unit connection function for more channels (/SY or /SYN option) **NEW!**

Supported models **DLM5000HD** **DLM3000HD** **DLM5000**

Connecting two DLM5000HD/DLM5000/DLM3000 Series models (with /SY or /SYN option) with a dedicated cable (701982) enables synchronous measurement of up to 16 channels. Captured waveforms are displayed on each unit. Triggers operate in common, and common settings as record length, sample rate, acquisition settings and horizontal axis scale settings, are linked, so they can be used like a single 16-channel oscilloscope.

*For the DLM3000HD, /SY option can be ordered only with the main unit.

*DLMsync is available only between the same models. Different models cannot be connected through this feature.



IEEE1588 integrated measurement master function (/CY option) **NEW!**

Supported models **DLM5000HD** **DLM3000HD**

The DLM5000HD/DLM3000HD can be set as the master unit for time-synchronized measurement using IEEE1588. This function connects measuring instruments in a LAN network to each other without a dedicated cable or complex settings for synchronization, allowing you to start synchronized measurements easily. All measured data and results can be analyzed on the same time axis on IS8000.

*/CY option is available only on the DLM5000HD/DLM3000HD. The DLM5000 supports only the IEEE1588 slave function. The DLM3000 does not support the IEEE1588 master or slave function.

*IEEE 1588 is a standard for the Precision Time Protocol (PTP), a protocol for high-precision time synchronization of networked instruments and control systems. It provides clock synchronization with an error of less than 1 μs.

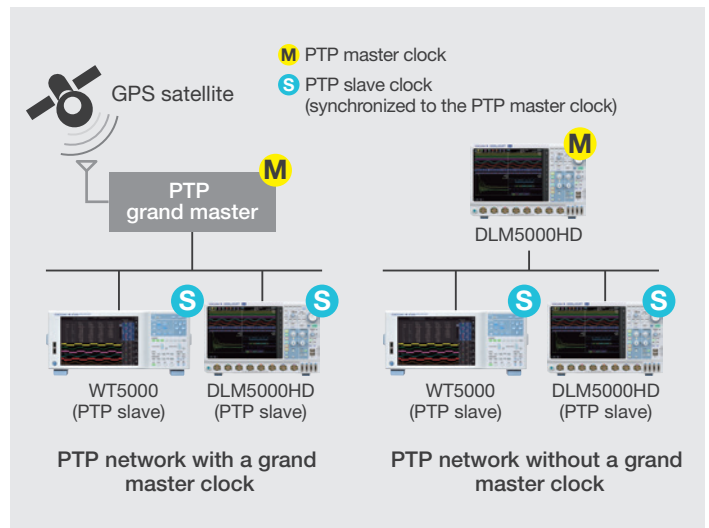

Superior noise immunity

Supported models **DLM5000HD** **DLM3000HD** **DLM5000** **DLM3000**

The DLM series is designed to be resistant to noise, and its touch panel is less likely to malfunction even in highly noisy environments.

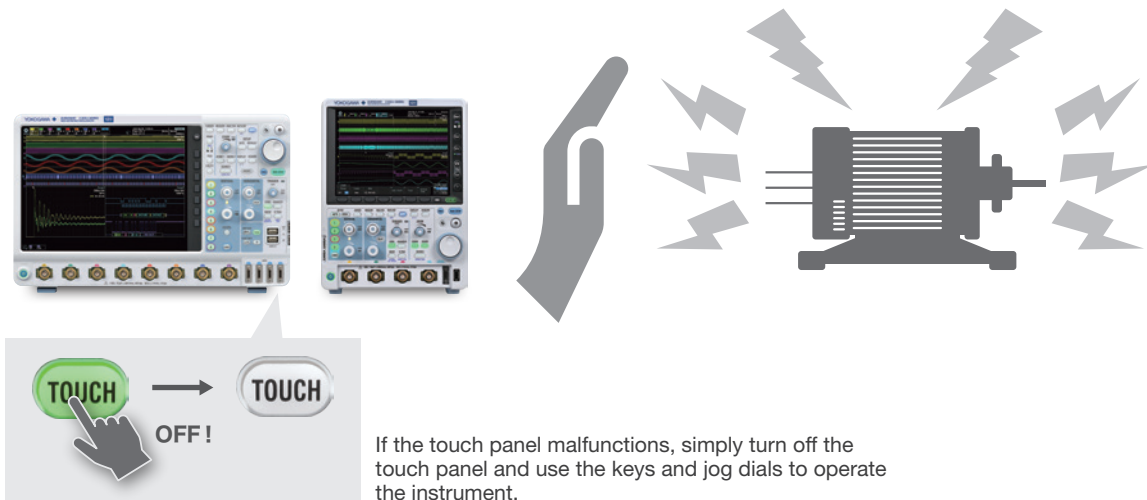

Easy to use portrait design

Supported models **DLM3000HD** **DLM3000**

The large display of a DLM3000HD/DLM3000 is located above the controls; making it easy to see and keeps the footprint on the bench to a minimum.



Footprint is approximately 2/3 the size of an A4 size paper (depth of approximately 200 mm)

Variety of display options

Supported models **DLM5000HD** **DLM3000HD** **DLM5000** **DLM3000**

The DLM series is equipped with a large touchscreen which is useful for observing analog signals in detail and displaying information for debugging such as measurement parameters, zoom displays, XY displays, and FFT analysis results.

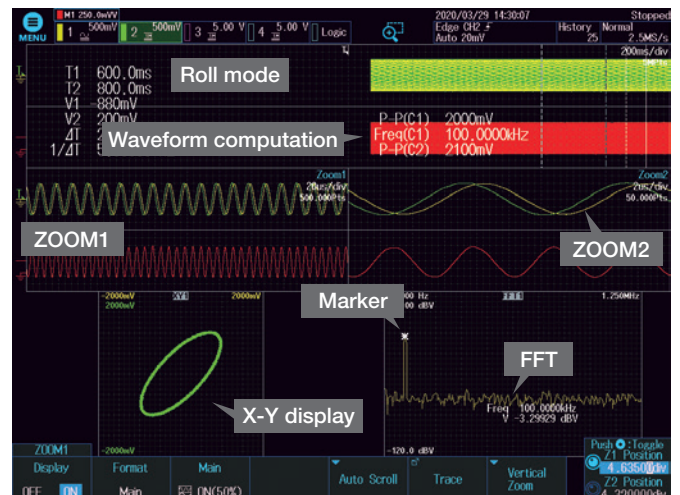

Functionality

Large selection of triggers

Supported models **DLM5000HD** **DLM3000HD** **DLM5000** **DLM3000**

The DLM series comes with a variety of easy-to-configure triggers such as edge, enhanced, and B triggers and can combine analog and logic inputs.

Trigger types

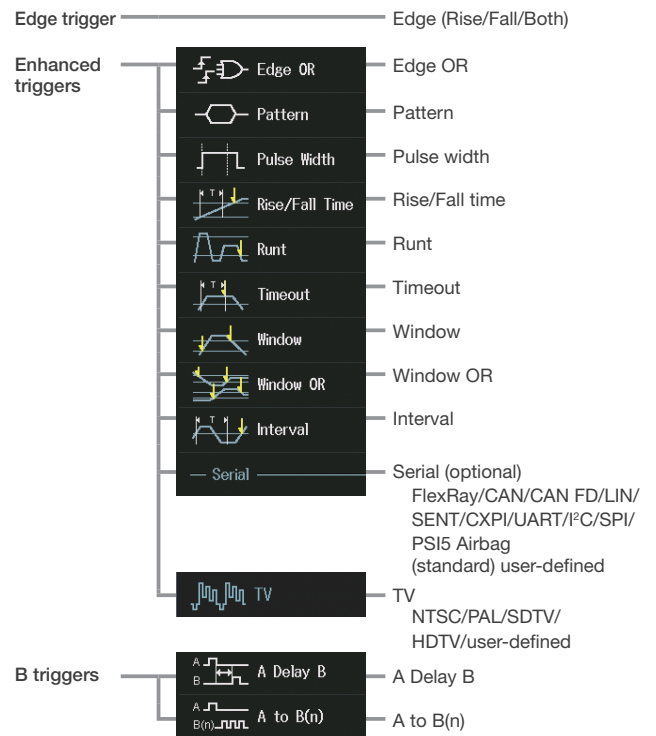

Filter functions

Supported models **DLM5000HD** **DLM3000HD** **DLM5000** **DLM3000**

Real time filter with optimum noise reduction supports a wide range of frequencies — from 8 kHz to 200 MHz — Each channel has 14 low pass filters available with cutoff frequencies from 8 kHz to 200 MHz. Waveforms are filtered prior to storage in memory. Real-time filters allow for stable triggering of superimposed noise signals.

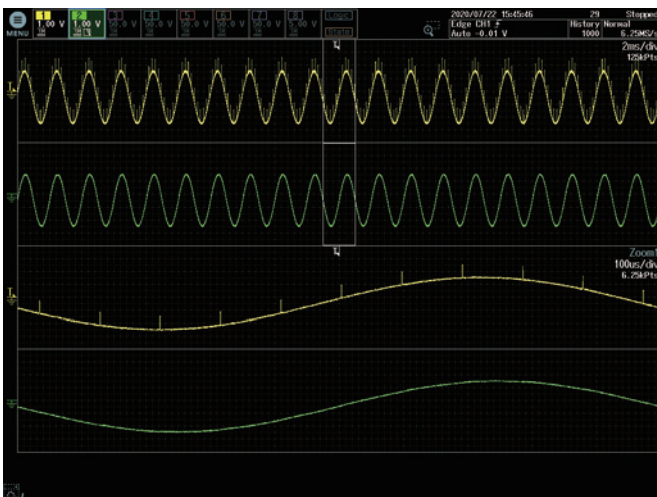

Processing with Real time filters

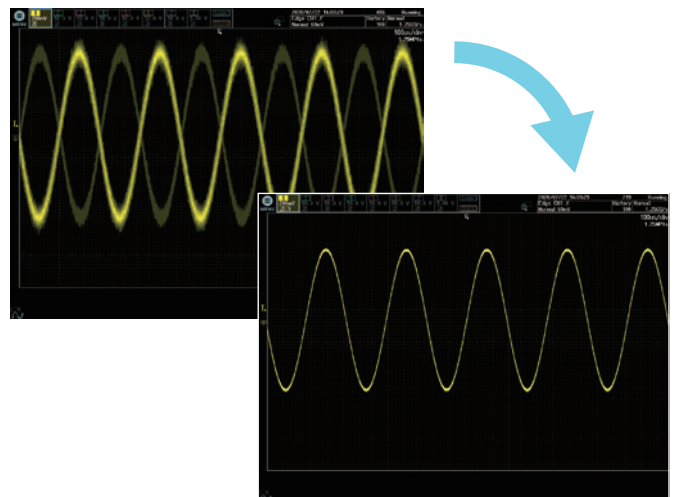

Stable trigger as a result of noise reduction

Zoom and search function

Supported models **DLM5000HD** **DLM3000HD** **DLM5000** **DLM3000**

Multi-channel waveforms captured with long memory need to be zoomed in vertically and horizontally for detailed viewing. The DLM series has dedicated zoom keys and knob, allowing you to quickly zoom in on the part you want to see. You can also specify the area you want to zoom in on by using the touch screen.

Zoom two locations simultaneously

You can display two zoomed waveforms with different time axis scales at the same time. Also, use Auto Scroll to sweep the zoom window across the waveforms automatically. Being able to zoom in on two distant locations at the same time, such as “cause” and “effect” of a certain event, or to display them with different zoom factors is very useful for software debugging.

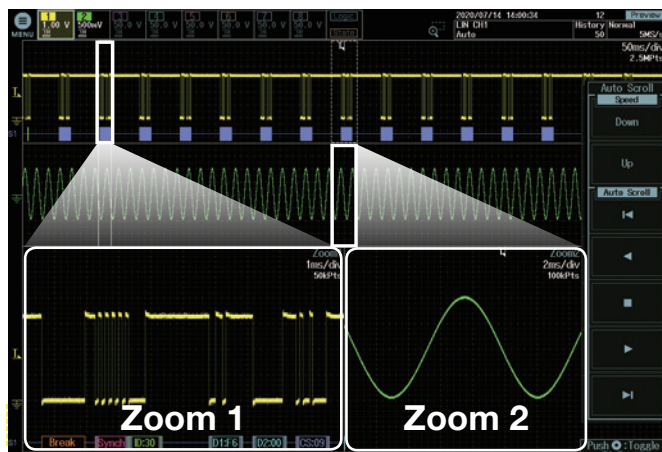

Zoom search function

Use several search criteria to automatically find and zoom into features in the waveform for further inspection. The locations of the found waveforms are marked on screen (▼ shows the current location).

Waveform search criteria

Edge, edge (qualified), state/pattern, pulse width, state width, serial bus (only on models with the serial bus analysis option)

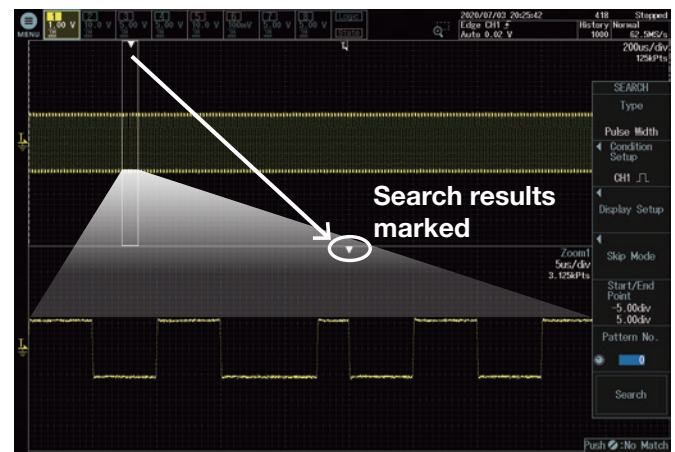

Waveform search by pulse width

Touchscreen

Supported models **DLM5000HD** **DLM3000HD** **DLM5000** **DLM3000**

By using the touchscreen to move the waveform position, change the scale, move the cursor, and more, you can operate the instrument without taking your eyes off the waveform. If you want to zoom in a part of the waveform, use Rect Zoom for easy zooming by swiping your finger diagonally across the screen to specify the area. To select items on the dialog box, you can directly touch them, which eliminates the trouble of using select keys.

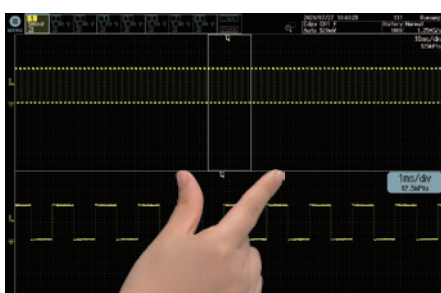

Changing zoom ratio by pinching in and out

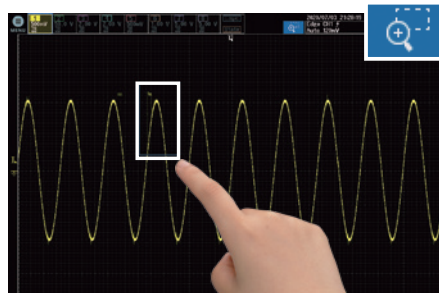

Rect Zoom



Selecting waveform parameter items

Logic signal measurement and analysis Supported models **DLM5000HD** **DLM5000**

The DLM5000HD/DLM5000 comes standard with 16 bit logic inputs. With the /L4 or /L32 option, up to 32 logic signals can be measured.

Bus/State display and optional DA calculation function (/G2 or /G02 option), which is useful for evaluating AD/ DA converters, are also available.

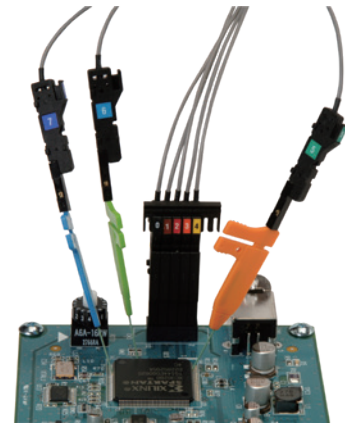
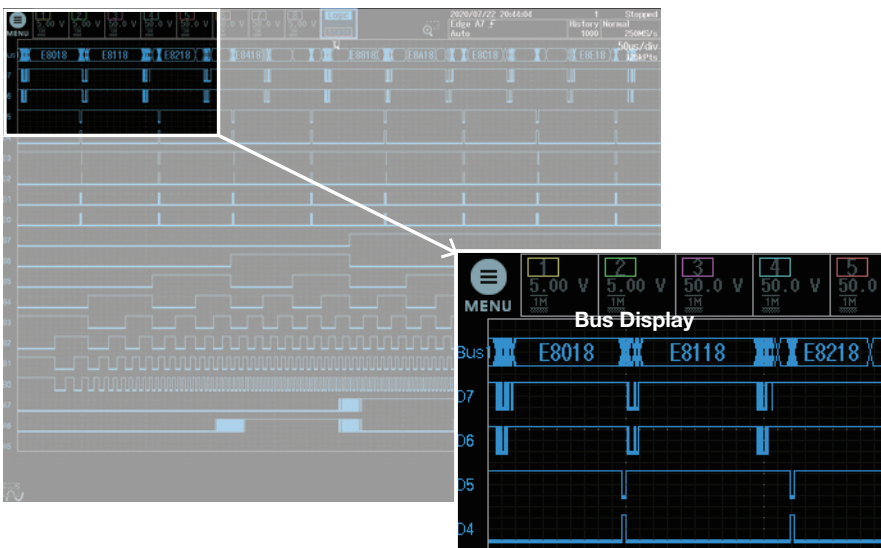

Flexible MSO input Supported models **DLM3000HD** **DLM3000**

The DLM3000HD/DLM3000 can convert the 4th channel analog input to 8-bit logic to function as a 3 ch analog + 8-bit logic MSO (mixed signal oscilloscope).

Logic inputs can be used not only to observe data signals or as trigger sources, but also for serial bus analysis such as I²C-bus and SPI-bus.

*Logic inputs require a logic probe (sold separately).



4 ch analog

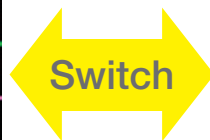

3 ch analog + 8-bit logic

Functions to improve operational efficiency

Supported models **DLM5000HD** **DLM3000HD** **DLM5000** **DLM3000**

Displays trends of peak-to-peak or pulse width per cycle

Measure function and statistics

Twenty-nine waveform parameter measurements are included. Automated measurement of up to 120 simultaneous measurements is available. Statistical values can also be measured continuously, cycle-by-cycle or using history memory. In addition, cycle-by-cycle parameter measurement is possible to calculate fluctuations of a captured waveform.

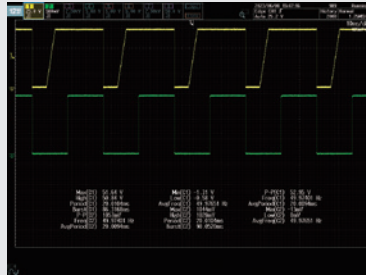

Automated measurement

Trend and histogram displays

Waveform parameters such as period, pulse width, and amplitude can be measured repeatedly and displayed in graphs. In a single screen you can observe period-by-period fluctuations, compute amplitudes using multiple waveforms, and display amplitudes as trends. You can also display histograms referencing the voltage or time axis using values from repeated automated measurement of waveform parameters.

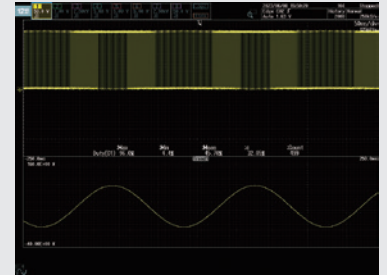

Trend display of waveform parameters

Measures voltage/time differences automatically

Cursor Measurement

Cursors can be placed on the displayed waveform from signal data, and various measurement values at the intersection of the cursor and waveform can be displayed. There are five types of cursor; ΔT , ΔV , $\Delta T \& \Delta V$, Marker, Degree Cursor.

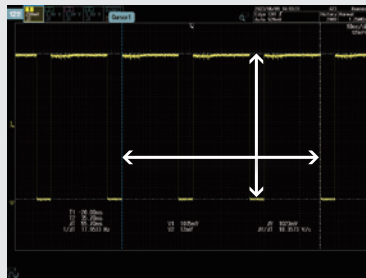

Simultaneous level and time difference measurement with the ΔT & ΔV cursor

Analyzes frequency spectra

FFT analysis

Up to 4 FFT analyses can be performed simultaneously. FFT can be performed on computed waveforms in addition to the actual waveforms on each analog input. The peak detection function that automatically detects the spurious frequency is a useful feature when searching for a noise source, such as clock and power supply switching noise.

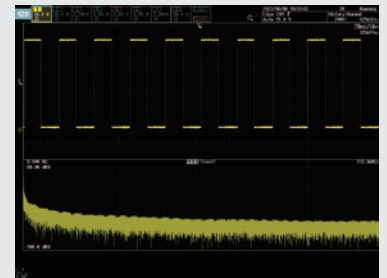

FFT analysis

Keeps waveforms with one push of a button

Snapshot

By pressing the "SNAP SHOT" key to the lower right of the screen, you can freeze a white trace of the currently displayed waveform on the screen. You can press the key repeatedly and accumulate traces for comparing multiple waveforms. Also, snapshot data recorded on screen can be saved or loaded as files, and can be recalled for use as reference waveforms when making comparisons.

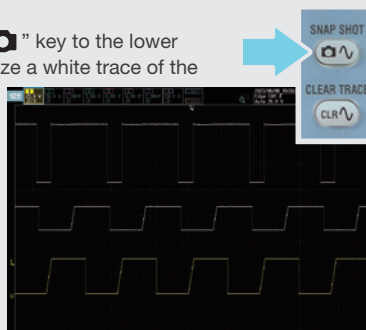

Using snapshots (white waveforms)

Displays stored files in thumbnail format

Thumbnails of saved files

Display thumbnails of saved waveforms, waveform images, and Wave Zone files for easier browsing, copying or deleting. A full-size view shows even more details.



Thumbnails of saved files

GO/NO-GO function, Action on trigger

GO/NO-GO automates pass or fail determination for trigger conditions, waveforms, measured parameters, and other criteria. Actions automate buzzer sounds, file saving, or email notification. Waveforms in which an abnormality occurred can be saved for confirmation and analysis of the phenomena at a later time.

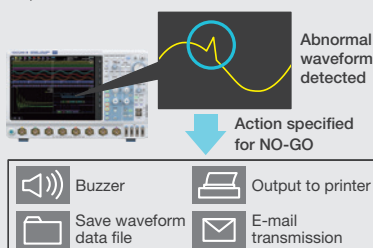

Graphical help

Get help without having to find the user manual. Pressing the "?" key opens detailed graphical explanations of the oscilloscope's functions.



Application-specific analysis options

Serial analysis function options (/F1 to /F6, /F01 to /F06)

Supported models DLM5000HD DLM3000HD DLM5000 DLM3000

UART (RS232) /I²C/SPI/CAN/CAN FD/LIN/FlexRay/SENT/CXPI/PSI5 Airbag

Dedicated trigger and analysis options are available for various serial buses of both in-vehicle and embedded systems. Logic input can also be used for I²C/SPI/UART/SENT. When it is not necessary to observe waveform quality of a bus, decoding or analysis using logic inputs is possible.

Unique auto setup

Yokogawa's proprietary auto setup function automatically analyzes the input signal or captured waveforms and complex parameters such as bit rate and threshold level, selecting the optimal settings in seconds. This feature not only saves time but is also a powerful debugging feature when the bit rate and other parameters are unknown.

Simultaneous analysis of up to 4 buses

Perform high-speed simultaneous analysis on up to four different serial buses operating at different speeds. Extensive search capabilities enhance the usability, allowing the user to find specific data in the memory. The dual-zoom feature means that different buses can be viewed and debugged alongside each other.

Serial Bus											
S1: SENT			S2: CAN FD			S3: I2C			S4: CXPI		
No.	Time(us)	Synch	No.	Time(us)	Frame	No.	Time(us)	1st	No.	Time(us)	ID
-5	-4.6380	168	0	-0.0680		-6	-3.9792	7C*	-4	-19.2208	P
-4	-3.7860	168	1	0.5660	Data	-5	-3.7952	4E*	-3	-17.6624	10
-3	-2.9340	168	2	1.1820	Data	-4	-2.6512	1C*	-2	-14.7536	7C
-2	-2.0820	168	3	1.8340	FD I	-3	-2.4672	36*	-1	-11.1632	01
-1	-1.2300	168	4	2.3980	FD I	-2	-1.3232	2C*	0	-5.5592	P0A
0	-0.3780	168	5	2.9620	FD I	-1	-1.1332	2C*	1	5.4532	10
1	0.4740	168	6	3.5300	FD I	0	0.0048	2C*	2	8.3620	7C
2	1.3260	168	7	4.0980	FD I	1	0.1888	3A*	3	11.9464	01
3	2.1780	168	8	4.7000	FD I	2	1.3328	1C*	4	17.5560	P50
4	3.0300	168	9	5.3020	FD I	3	1.5168	4E*	5	24.5164	10
5	3.8820	168	10	5.9140	FD I	4	2.6608	7D*			
6	4.7340	168	11	6.0152	Erro	5	2.8448	4E*			

4-bus list display

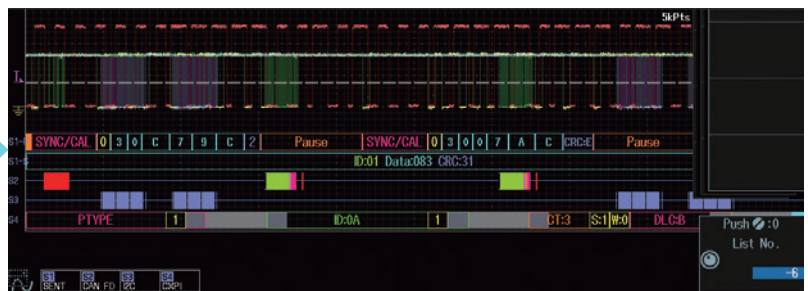
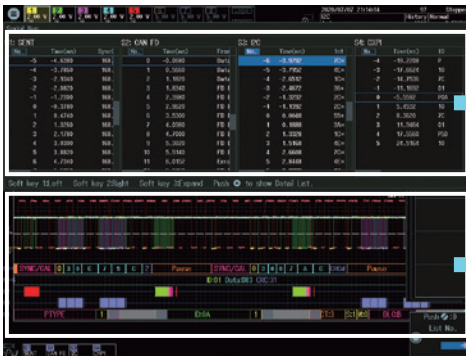

Waveform display and decode results

Related accessories (sold separately)

Differential probe PBDH0500 (701925)

DC to 500 MHz bandwidth
 Input impedance 1 MΩ, approximately 1.1 pF
 Maximum differential input voltage range: ±25 V

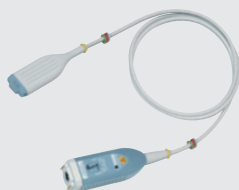

Logic probe PBL100/PBL250 (701988/701989)

100 MHz/250 MHz toggle frequency
 Input impedance 1 MΩ, 10 pF/100 kΩ, 3 pF

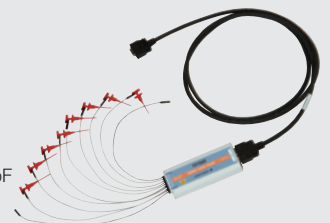

User defined math option (/G2 or /G02) Supported models **DLM5000HD** **DLM3000HD** **DLM5000** **DLM3000**

Equations can be arbitrarily created using a suite of operators such as trigonometric and logarithmic operators, integration and differentiation, pulse width operators, phase measurement and digital to analog conversion.

Power supply analysis option (/G3 or /G03) Supported models **DLM5000HD** **DLM3000HD** **DLM5000** **DLM3000**

Switching loss analysis

Calculate switching loss $[V(t) \times i(t)]$ over long test cycles utilizing the long built-in memory. A wide variety of switching loss analyses are supported, including turn-on/off loss calculation, loss including continuity loss, and loss over long cycles of 50 Hz/60 Hz power line.

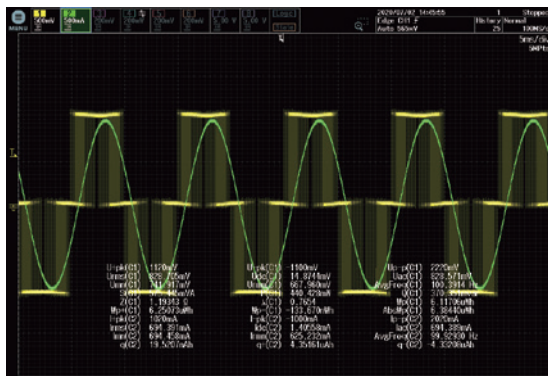
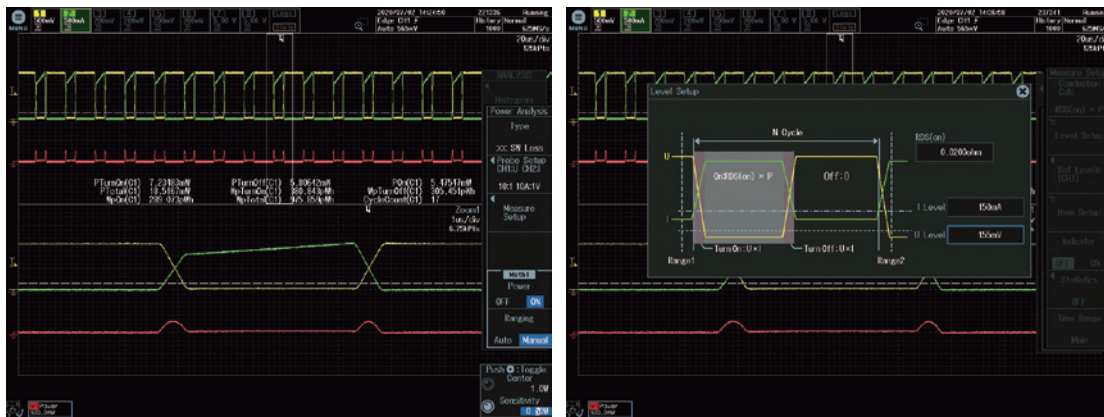

Power parameter measurement

Measure power parameters automatically for up to four pairs of voltage and current waveforms, such as active power, apparent power, power factor, and more. Cycle statistics and history statistics can also be calculated.

Related accessories (sold separately)

Differential probe PBDH0150 (701927)

DC to 150 MHz
1000 Vrms/ ±1400 Vpeak

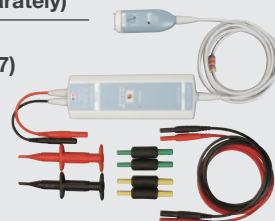

Current probe PBC100/PBC050 (701928/701929)

DC to 100 MHz (701928)
DC to 50 MHz (701929)
30 Arms

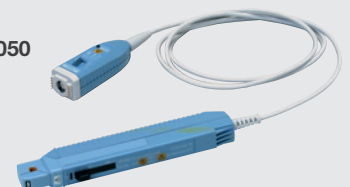

Applications

Development of motor/inverter circuits to perform high voltage switching

The DLM5000HD/DLM3000HD is a high-definition oscilloscope ideal for measuring fast switching of inverters. It can measure eight channels simultaneously at up to 2.5 GS/s with bandwidths of up to 500 MHz and provide high-precision analysis with 12-bit resolution. In addition, DLMsync allows two DLM5000HD/DLM3000HD Series models to be connected easily and evaluation tests to be completed simultaneously by performing multi-point measurements.

The SW Loss math function is effective for inverter characterization and provides powerful analysis support. A full line of accessories for high voltages is also available for inverter development.

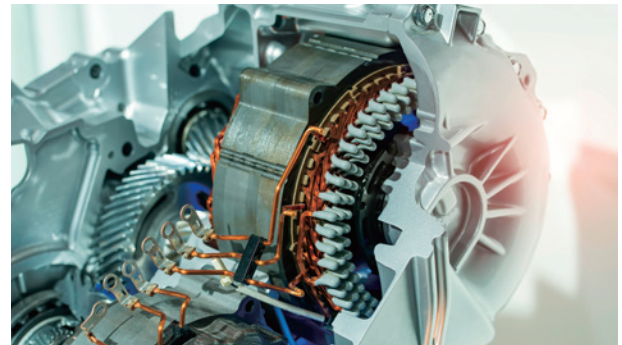
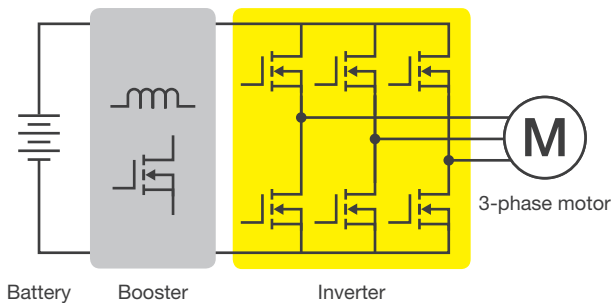

Example.

- Measuring 3 line voltages and 3 phase currents of a 3-phase motor at the same time
- Measuring gate control signals of 6 SiCs in an inverter at the same time

Automotive electronic control unit and mechatronics embedded device development

Digital waveform analysis using logic inputs alone cannot reveal anomalies such as voltage drift, noise, distortion or ringing, and measure rise-fall times. ECU testing requires stringent examination of all digital waveforms – and analog input channels are the best tool for the job.

Numerous I/O analog, digital, and serial-bus waveforms surrounding the electronic control unit (ECU) must be measured. The DLM5000HD/DLM3000HD offers ample channel-count and architecture to monitor eight analog channels and up to 32-bits of logic input while simultaneously performing protocol analysis such as UART, I²C, SPI, CAN, CAN FD, LIN, CXPI, PSI5, and FlexRay.

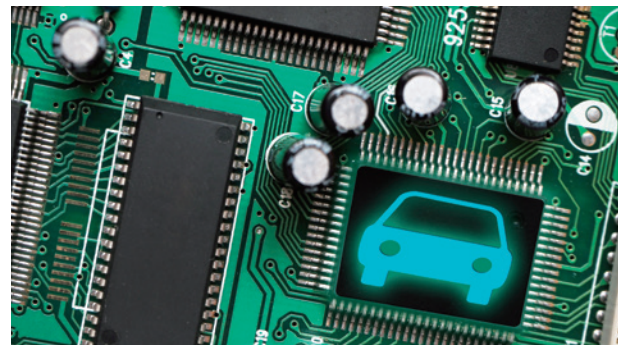
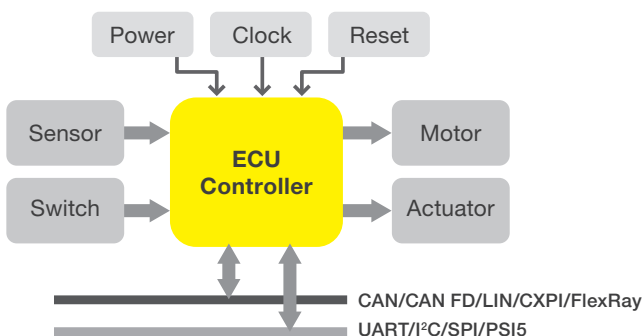

Example.

- Measuring controller I/O signals and serial bus signals at the same time
- Measuring the analog behavior of logic signals and serial bus signals

Integrated Measurements

Integrated Software Platform IS8000

The IS8000 software enables you to remotely control, monitor and configure Yokogawa’s high-precision power analyzers, high-speed recorders and oscilloscopes.

It also enables synchronized measurements with ECU monitors, high-speed cameras, and Modbus/TCP communication devices, greatly reducing the burden of operating and managing various instruments to measure power, sensor waveforms, video, and control signals.



Other software

Category	Software	Features/Description	Off-line waveform display and analysis	Waveform monitoring on a PC	Data transfer to a PC	Command control Custom software development
Optional Software	Integrated Software Platform Download site: <https://tmi.yokogawa.com/p/is8000/> IS8000	An integrated solution that accelerates engineering workflow	Yes	Yes	Yes	Support for APIs
	IS8002CDV	Equipped with Xviewer function. Remote control of the instruments using the PC. Waveform observation and analysis <ul style="list-style-type: none"> Cursor, Parametric Measure Statistical Analysis Multiple file display Remote monitor Comment, marking, printing and making report Optional Math computation feature On-line communication functions Transferring waveform & image files 	Yes	Yes	Yes	No
Free Software	Integrated Software Platform Download site: <https://tmi.yokogawa.com/p/is8000/> IS8000 (Simple)	<ul style="list-style-type: none"> Load wdf files Max number of display channels: 8 CH × 1 Group Max number of zoom screens/Max number of X-Y screens: 1/1 Cursor function, history data display 	Yes Limited functions	No	No	No
	XWirepuller	Control the DL (M) series from the PC	No	Yes	Yes	No
	Control library “TMCTL”	Create programs and control the instrument remotely	No	No	No	Yes
	DL-Term	Command line tool for the DL series library	No	No	No	Yes
	LabVIEW drivers (for DLM5000/950)	Instrument driver for DL950 and DLM5000 *Program development environment provided by National Instruments (NI)	No	No	No	Yes
MATLAB WDF Access ToolBox	Access to waveform data files saved in WDF format on MATLAB*. *MathWorks’s product.	No	No	No	Yes	

Correspondence: Yes Incompatible: No

Stable and reliable purpose-built operation system

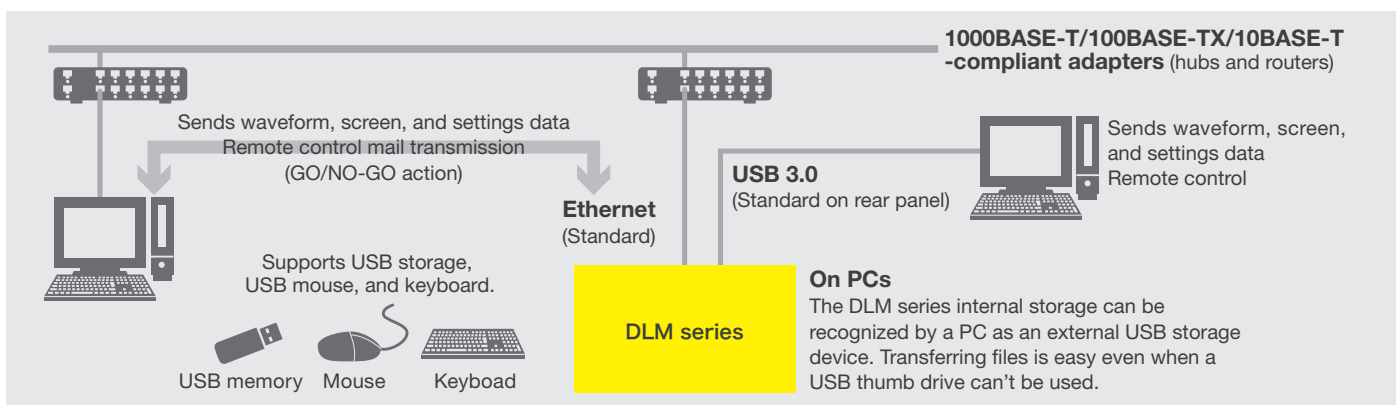

Intuitive control panel and connectivity

DLM5000HD/DLM5000 *The photo shows the 8-channel model.

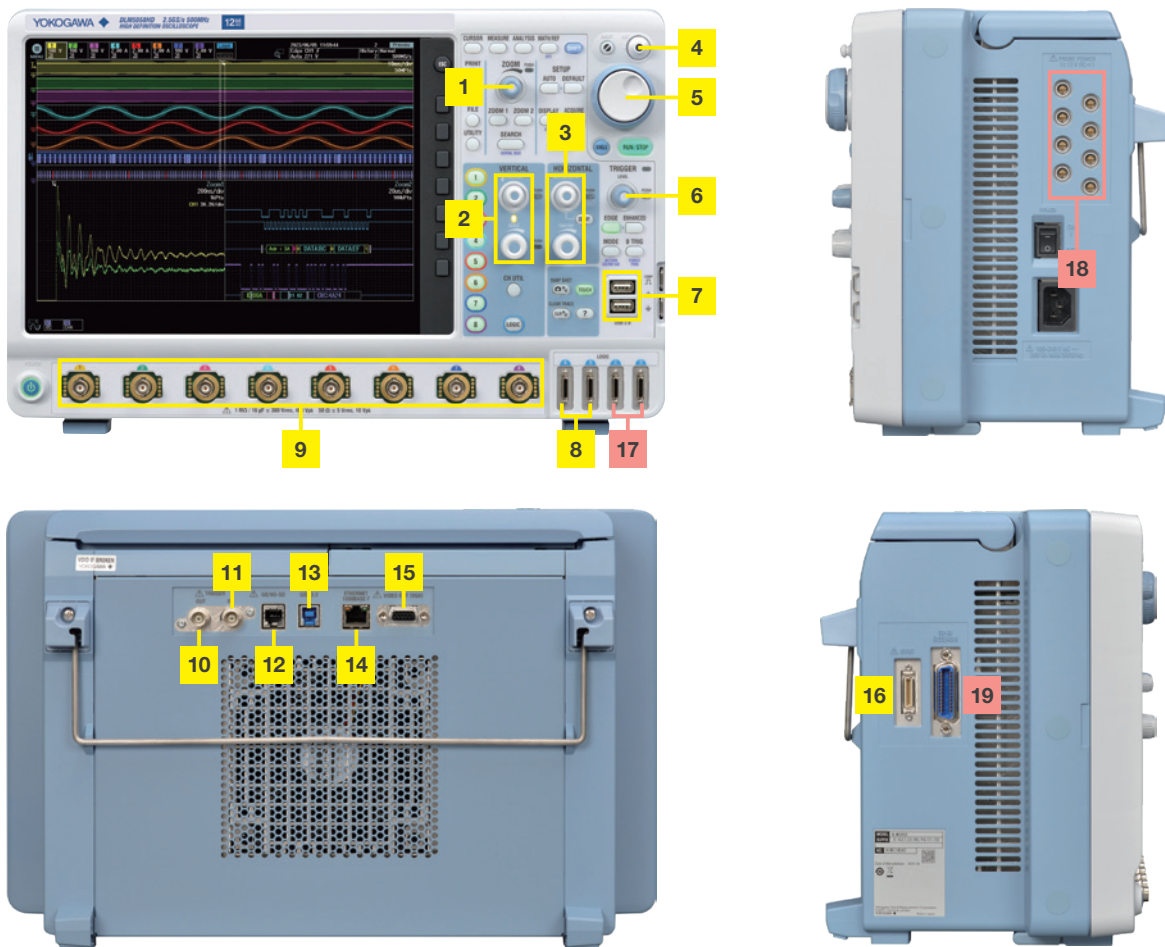

Standard equipment

Optional

- | | |
|--|---|
| 1 Dedicated Zoom Knob | 9 Eight Analog Input Channels ^{*1} |
| 2 Vertical Position and Scale Knob | 10 External trigger output |
| 3 Horizontal Position and Scale Knob | 11 External trigger input |
| 4 Four-Direction Selector Button Select key moves the cursor up/down/left/right | 12 GO/NO-GO output terminal |
| 5 Jog Shuttle and Rotary Knob | 13 USB-PC connection terminal |
| 6 Dedicated Trigger Level Knob | 14 1000 BASE-T Ethernet |
| 7 USB peripheral connection terminal × 2 | 15 RGB video output terminal |
| 8 Logic input connector 16 bit | 16 Synchronous operation terminal (for DLMsync ^{*2}) |

- | |
|---|
| 17 Logic input connector 16 bit |
| 18 Probe power supply terminal × 8 ^{*3} |
| 19 GP-IB connection terminal |

^{*1}: Four ch model has 4 analog inputs

^{*2}: Option is required for feature activation

^{*3}: Four ch model has 4 terminals

DLM3000HD/DLM3000 *The photo shows the 4-channel model.

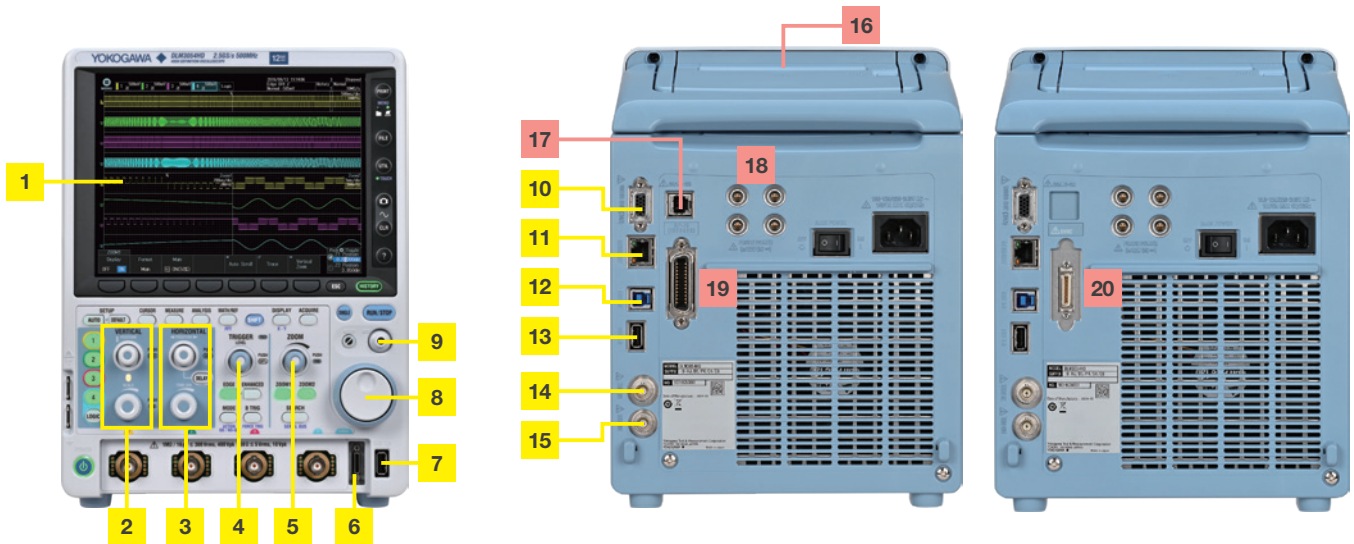

Standard equipment

- 1** 8.4-inch XGA LCD & Capacitive touchscreen
- 2** Vertical Position and Scale Knob
- 3** Horizontal Position and Scale Knob
- 4** Trigger Control Keys and Level Knob
- 5** Dedicated Zoom Keys
- 6** Logic input connector
- 7** USB peripheral connection terminal
- 8** Jog Shuttle and Rotary Knob
- 9** Four-Direction Selector Button
Select key moves the cursor up/down/left/right
- 10** RGB video signal output terminal
- 11** Ethernet
- 12** USB-PC connection terminal
- 13** USB peripheral connection terminal
- 14** External trigger input
- 15** Trigger output

Optional

- 16** Build-in printer
- 17** GO/NO-GO output terminal¹
- 18** Probe power supply terminal x 4²
- 19** GP-IB connection terminal¹
- 20** Synchronous operation terminal (for DLMsync)³

*1: Only when /C1 option is selected

*2: x2 for 2-channel models

*3: Only when /SY option is selected and only for DLM3000HD. (excl. /C1 option and /SY option)

Increase work efficiency by using a PC

The totally new CPU platform of the DLM series is equipped with Gigabit Ethernet and USB 3.0¹ as standard communication interfaces, handling data faster than ever.

For example, the DLM series is 10 times faster at saving to internal storage and about 10 times faster when transferring to a PC². Get answers faster, even with large data sets.

*1: USB function only. USB host function uses USB2.0 communication.

*2: When /C8 option (SSD) is installed for internal storage and USB3.0 mass storage connection is used for transfer.

Compare with the conventional model (DLM4000/DLM2000).

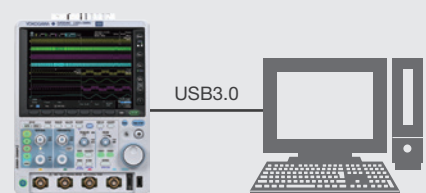

Specifications

(On the 4-channel model, CH8 should be read as CH4 and M8 should be read as M4.)

Models						
Model name	Frequency bandwidth	Analog input	Logic input	A/D resolution	Max. sample rate	
DLM3022	200 MHz	2 channels	—	8 bit	2.5 GS/s	
DLM3032	350 MHz					
DLM3052	500 MHz					
DLM3024	200 MHz	4 channels	8 bit			
DLM3034	350 MHz					
DLM3054	500 MHz					
DLM5034	350 MHz	4 channels	16 bit (Standard) or 32 bit (Option)	12 bit		
DLM5054	500 MHz					
DLM5038	350 MHz					
DLM5058	500 MHz	8 channels	16 bit (Standard) or 32 bit (Option)			
DLM3034HD	350 MHz				4 channels	8 bit
DLM3054HD	500 MHz					
DLM5034HD	350 MHz	4 channels	16 bit (Standard) or 32 bit (Option)			
DLM5054HD	500 MHz					
DLM5038HD	350 MHz			8 channels	16 bit (Standard) or 32 bit (Option)	
DLM5058HD	500 MHz					

Analog Signal input		
Input channels	Model name	Analog inputs
	DLM30x2	CH1, CH4 (2 ch model)
	DLM30x4/DLM30x4HD	CH1 to CH4 (CH1 to CH3 when using logic input) (4 ch model)
	DLM50x4/DLM50x4HD	CH1 to CH4 (4 ch model)
	DLM50x8/DLM50x8HD	CH1 to CH8 (8 ch model)
Input coupling setting	AC 1 M Ω , DC 1 M Ω , DC 50 Ω	
Input impedance	Analog input: 1 M Ω \pm 1.0%, approximately 16 pF 50 Ω \pm 1.0% (VSWR 1.4 or less, DC to 500 MHz)	
Voltage axis sensitivity setting range	1 M Ω : 500 μ V/div to 10 V/div (steps of 1-2-5) 50 Ω : 500 μ V/div to 1 V/div (steps of 1-2-5)	
Max. input voltage	1 M Ω : Must not exceed 300 Vrms or 400 Vpeak 50 Ω : Must not exceed 5 Vrms or 10 Vpeak	
Max. DC offset setting range	1 M Ω : 500 μ V/div to 50 mV/div \pm 1 V 100 mV/div to 500 mV/div \pm 10 V 1 V/div to 10 V/div \pm 100 V 50 Ω : 500 μ V/div to 50 mV/div \pm 1 V 100 mV/div to 1 V/div \pm 5 V	
Vertical-axis (voltage-axis) DC accuracy ¹	500 μ V/div: \pm (3.0% of 8 div + offset voltage accuracy) 1 mV/div to 10 V/div: \pm (1.5% of 8 div + offset voltage accuracy)	
Offset voltage accuracy ¹	500 μ V to 50 mV/div: \pm (1% of setting + 0.2 mV) 100 mV to 500 mV/div: \pm (1% of setting + 2 mV) 1 V to 10 V/div: \pm (1% of setting + 20 mV)	

Frequency characteristics (–3 dB attenuation when inputting a sinewave of amplitude \pm 3 div)^{1,2}

	DLM302x	DLM303x DLM503x DLM3034HD DLM503xHD	DLM305x DLM505x DLM3054HD DLM505xHD
1 M Ω (when using attached 10:1 passive probe)	20 mV to 100 V/div	200 MHz	350 MHz
	10 mV/div	200 MHz	350 MHz
	5 mV/div	200 MHz	200 MHz
50 Ω	2 mV to 1 V/div	200 MHz	350 MHz
	1 mV/div	200 MHz	350 MHz
	500 μ V/div	200 MHz	200 MHz

–3 dB attenuation point for AC coupling
Approx. 1 Hz (with direct input), 1 Hz or less (with the supplied 10:1 probe)

Isolation between channels (Maximum bandwidth)	DLM30xx/DLM50xx	–34 dB (typical value) ⁷
	DLM30xxHD/DLM50xxHD	–65 dB (typical value) ⁸
Residual noise level ³	DLM30xx/DLM50xx	The larger of 0.2 mVrms or 0.05 div rms (typical value)
	DLM3034HD	110 μ Vrms (2 mV/div) (typical value)
	DLM3054HD	150 μ Vrms (2 mV/div) (typical value)
	DLM503xHD	103 μ Vrms (2 mV/div) (typical value)
	DLM505xHD	134 μ Vrms (2 mV/div) (typical value)

A/D resolution	DLM30xx/DLM50xx	8 bit (25 LSB/div) Max. 12 bit (in High Resolution mode)
	DLM30xxHD/DLM50xxHD	12 bit (400 LSB/div) Max. 16 bit (in High Resolution mode)
Bandwidth limit	FULL, 200 MHz, 100 MHz, 20 MHz, 10 MHz, 5 MHz, 2 MHz, 1 MHz, 500 kHz, 250 kHz, 125 kHz, 62.5 kHz, 32 kHz, 16 kHz, 8 kHz (can be set for each channel)	
Maximum sample rate	Real time sampling mode: 2.5 GS/s Repetitive sampling mode: 250 GS/s	

Maximum record length (Points) DLM30xx/DLM30xxHD		
	Repeat	Single (when odd ch only)
2 ch model	12.5 M	50 M (125 M)
4 ch model	12.5 M	50 M (125 M)
/M1	25 M	125 M (250 M)
/M2	50 M	250 M (500 M)
/M3	125 M	500 M (1 Giga)

¹2ch model is applicable to DLM30xx only. /M3 is applicable to DLM30xxHD only.

DLM50xx/DLM50xxHD		
	Repeat	Single (when odd ch only)
Standard model	12.5 M	50 M (125 M)
/M1 or /M1S	25 M	125 M (250 M)
/M2 or /M2S	50 M	250 M (500 M)
/M3 or /M3S	125 M	500 M (1 Giga)

¹/M3 or /M3S are applicable to DLM50xxHD only

Ch-to-Ch deskew	\pm 1 μ s
Time axis setting range	1 ns/div to 500 s/div (steps of 1-2-5)
Time base accuracy ¹	DLM30xx/DLM30xxHD: \pm 20 ppm DLM50xx/DLM30xxHD/DLM50xxHD: \pm 2.5 ppm (at shipping or calibration), \pm 1.0 ppm/year (ageing)
Dead time in N Single mode	DLM30xx: Approx. 0.9 μ s DLM50xx: Approx. 1.6 μ s DLM50xxHD: Approx. 1.2 μ s DLM30xxHD: Approx. 0.4 μ s

Logic Signal Input ¹ *Except DLM30x2 (2 ch)							
Number of inputs	DLM30xx/DLM30xxHD 8 bit (excl. CH4 input and logic input)						
	DLM50xx/DLM50xxHD						
	<table border="1"> <tbody> <tr> <td>Standard</td> <td>8 bit \times 2</td> <td>Port A, Port B</td> </tr> <tr> <td>/L4, /L32</td> <td>8 bit \times 4</td> <td>Port A, Port B, Port C, Port D</td> </tr> </tbody> </table>	Standard	8 bit \times 2	Port A, Port B	/L4, /L32	8 bit \times 4	Port A, Port B, Port C, Port D
Standard	8 bit \times 2	Port A, Port B					
/L4, /L32	8 bit \times 4	Port A, Port B, Port C, Port D					
Maximum toggle frequency ¹	Model 701988: 100 MHz, Model 701989: 250 MHz						
Compatible probes	701988, 701989 (8 bit input)						
Min. input voltage	701988: 500 mVp-p, 701989: 300 mVp-p						
Input range	Model 701988: \pm 40 V Model 701989: threshold \pm 6 V						
Max. nondestructive input voltage	Model 701988: \pm 42 V (DC + ACpeak) or 29 Vrms Model 701989: \pm 40 V (DC + ACpeak) or 28 Vrms						
Threshold level setting range	Model 701988: \pm 40 V (setting resolution of 0.05 V) Model 701989: \pm 6 V (setting resolution of 0.05 V)						
Input impedance	701988: Approx. 1 M Ω /approx. 10 pF 701989: Approx. 100 k Ω /approx. 3 pF						
Maximum sample rate	1.25 GS/s						

Maximum record length (Points)		
	Repeat	Single
Standard	12.5 M	50 M (125 M)
/M1 or /M1S	25 M	125 M (250 M)
/M2 or /M2S	50 M	250 M (500 M)
/M3 or /M3S	125 M	500 M (1 Giga)

¹/M3 is applicable to the DLM30xxHD/DLM50x8HD only.
¹/M3S is applicable to the DLM50x4HD only.
¹When record lengths in parentheses are selected, DLM30xx/DLM30xxHD: acquisition with logic ports is not available. (Logic ports can be used for only a trigger source.)
DLM50xx/DLM50xxHD: only logic ports A and B are available.

Triggers	
Trigger modes	Auto, Auto Level, Normal, Single, N-Single, Force trigger
Trigger type, trigger source	
A triggers	Edge All analog input channels, Logic, EXT, LINE
Edge OR	All analog input channels
Pulse Width	All analog input channels, Logic
Timeout	All analog input channels, Logic
Pattern	All analog input channels, Logic
Runt	All analog input channels
Rise/Fall Time	All analog input channels
Interval	All analog input channels, Logic
Window	All analog input channels
Window OR	All analog input channels
TV	All analog input channels
Serial Bus	I ² C (optional) All analog input channels, Logic
	SPI (optional) All analog input channels, Logic
	UART (optional) All analog input channels, Logic
	FlexRay (optional) All analog input channels
	CAN (optional) All analog input channels
	CAN FD (optional) All analog input channels
	LIN (optional) All analog input channels
	SENT (optional) All analog input channels, Logic
	CXPI (optional) All analog input channels
	PSI5 Airbag (optional) All analog input channels
	User Define All analog input channels
AB triggers	A Delay B 10 ns to 10 s
	A to B(n) 1 to 10 ⁹
Trigger level setting range	All analog input channels ±4 div from center of screen
Trigger level setting resolution	All analog input channels 0.01 div (TV trigger: 0.1 div)
Trigger level accuracy ¹	All analog input channels ±0.04 div
Display	
Display ²	
DLM30xx/DLM30xxHD	8.4-inch TFT LCD with a capacitive touch screen, 1024 × 768 (XGA)
DLM50xx/DLM50xxHD	12.1-inch TFT LCD with a capacitive touch screen, 1024 × 768 (XGA)
Functions	
Waveform acquisition modes	Normal, Envelope, Average
High Resolution mode	DLM30xx/DLM50xx: Maximum 12 bit DLM30xxHD/DLM50xxHD: Maximum 16 bit
Sampling modes	Real time, Interpolation, Repetitive
Accumulation	Select OFF, Intensity (waveform frequency by brightness), or Color (waveform frequency by color) Accumulation time: 100 ms to 100 s, Infinite
Roll mode	Enabled at 100 ms/div to 500 s/div (depending on the record length setting)
Zoom function	Two zooming windows can be set independently (Zoom1, Zoom2)
	Zoom factor ×2 to 2.5 points/10 div (in zoom area)
	Scroll Auto Scroll
	Search functions Edge, Pulse Width, Timeout, Pattern, I ² C (optional), SPI (optional), UART (optional), CAN (optional), CAN FD (optional), LIN (optional), FlexRay (optional), SENT (optional), CXPI (optional), PSI5 Airbag (optional), User Define
History memory	Max. data (record length 1.25 k Points, with) Standard: 20000, /M1 or /M1S: 50000, /M2 or /M2S: 100000, /M3 or /M3S: 200000 *M3 and /M3S are applicable to the DLM50xxHD/DLM30xxHD only.
	History search Select Rect, Wave, Polygon, or Parameter mode
	Replay function Automatically displays the history waveforms sequentially
	Display Specified or average waveforms
Cursor	Types ΔT, ΔV, ΔT & ΔV, Marker, Degree
Snapshot	Currently displayed waveform can be retained on screen
Computation and Analysis Functions	
Parameter Measurement	Max, Min, P-P, High, Low, Amplitude, Rms, Mean, Sdev, IntegTY+, IntegTY, +Over, -Over, Pulse Count, Edge Count, V1, V2, ΔT, Freq, Period, Avg Freq, Avg Period, Burst, Rise, Fall, +Width, -Width, Duty, Delay
Statistical computation of parameters	Max, Min, Mean, σ, Count
Statistics modes	Continuous, Cycle, History
Trend/Histogram display of wave parameters	Up to 2 trend or histogram display of specified wave parameters

Computations (MATH)	+, -, ×, Filter (Delay, Moving Avg, IIR Lowpass, IIR Highpass), Integ, Count (Edge, Rotary), user defined math (optional)
Computable no. of traces	DLM30xx/DLM30xxHD 4 (M1 to M4) (2 traces for 2 ch model) (mutually exclusive with REF trace) DLM50xx/DLM50xxHD 8 (M1 to M8) (4 traces for 4 ch model) (mutually exclusive with REF trace)
Max. computable memory length	Same as the maximum record length
Reference function	DLM30xx/DLM30xxHD Up to 4 traces (REF1 to REF4) of saved waveform data can be displayed and analyzed. (mutually exclusive with MATH trace) DLM50xx/DLM50xxHD Up to 8 traces (REF1 to REF8) of saved waveform data can be displayed and analyzed. (4 traces for 4 ch model) (mutually exclusive with MATH trace)
Action-on-trigger	Actions: Buzzer, Print, Save, Mail
GO/NO-GO	Modes: Rect, Wave, Polygon, Parameter Actions: Buzzer, Print, Save, Mail
X-Y	Displays XY1 to XY4 and T-Y simultaneously (XY1, XY2 and T-Y for 4 ch model, XY1 and T-Y for 2 ch model)
FFT	Number of points: 1.25 k, 2.5k, 12.5 k, 25 k, 125 k, 250 k, 1.25 M Window functions: Rectangular, Hanning, Flat-Top FFT Types: PS (LS, RS, PSD, CS, TF, CH are available with /G2 or /G02 option)
Histogram	Displays a histogram of acquired waveforms
User-defined math (/G2 or /G02 option)	The following operators can be arbitrarily combined in equations: +, -, ×, /, SIN, COS, TAN, ASIN, ACOS, ATAN, INTEG, DIFF, ABS, SQRT, LOG, EXP, LN, BIN, DELAY, P2 (power of 2), PH, DA, MEAN, HLB, PWHH, PWLL, PWHL, PWLH, PWXX, FV, DUTYH, DUTYL, FILT1, FILT2 The maximum record length that can be computed is the same as the standard math functions.
Power supply analysis (/G3 or /G03 option)	
Power analysis	Selectable from 4 analysis types Deskewing between the voltage and current waveforms can be executed automatically.
Switching loss	Measurement of total loss and switching loss, power waveform display, Automatic measurement and statistical analysis of power analysis items (PTurn On, PTurn Off, POn, PTotal, WpTurn On, WpTurn Off, Wp On, WpTotal, Cycle Count)
Safety operation area	SOA analysis by X-Y display, using voltage as X axis, and current as Y axis is possible
Harmonic analysis	Basic comparison is possible with following standard Harmonic emission standard IEC61000-3-2 edition 4.0, EN61000-3-2 (2006), IEC61000-4-7 edition 2.1
Joule integral	Joule integral (I ² t) waveform display, automatic measurement and statistical analysis is possible
Power Measurement	DLM30xx/DLM30xxHD Automated measurement of power parameters for up to two pairs of voltage and current waveforms. Measured values can be statistically processed or calculated. DLM50xx/DLM50xxHD Automated measurement of power parameters for up to four pairs of voltage and current waveforms. Measured values can be statistically processed or calculated.
Measurement parameters	Urms, Umn, Udc, Urmn, Uac, U+pk, U-pk, U-p, Irms, Imn, Idc, Irmn, Iac, I+pk, I-pk, I-p, P, S, Q, Z, λ, Wp, Wp+, Wp-, Abs.Wp, q, q+, q-, Abs.q, Avg Freq (voltage, current)
Common Features of Serial Bus Signal Analysis Functions	
Analysis result display	Decoded information is displayed together with waveforms or in list form.
Auto setup function	A threshold value, time axis scale, voltage axis scale and other bus-specific parameters such as a bit rate and recessive level are automatically detected. Trigger conditions are set based on the detected result and decoded information is displayed. (The type of a bus signal needs to be specified in advance.)
Search function	Search of all waveforms for a position that matches a pattern or condition specified by data information.
Analysis result saving function	Analysis list data can be saved to CSV-format files.
I ² C Bus Signal Analysis Functions (/F1 or /F01 Option)	
Applicable bus	I ² C bus Bus transfer rate: 3.4 Mbit/s max. Address mode: 7 bit/10 bit SM bus Complies with System Management Bus
Analyzable signals	DLM30xx/DLM30xxHD: CH1 to CH4, Logic input, or M1 to M4 DLM50xx/DLM50xxHD: CH1 to CH8, Logic input, or M1 to M8
I ² C trigger modes	Every Start, Address & Data, NON ACK, General Call, Start Byte, HS Mode
Analyzable no. of data	300000 bytes max.

List display items	Analysis no., Time from trigger position [Time (ms)], 1st byte address, 2nd byte address, R/W, Data, Presence/absence of ACK, Information
--------------------	---

SPI Bus Signal Analysis Functions (/F1 or /F01 Option)

Trigger types	3 wire, 4 wire After assertion of CS, compares data after arbitrary byte count and triggers.
Analyzable signals	DLM30xx/DLM30xxHD: CH1 to CH4, Logic input, M1 to M4 DLM50xx/DLM50xxHD: CH1 to CH8, Logic input, M1 to M8
Byte order	MSB, LSB
Analyzable no. of data	300000 bytes max.

List display items	Analysis no., Time from trigger position [Time (ms)], Data 1, Data 2
--------------------	--

UART Signal Analysis Functions (/F1 or /F01 Option)

Bit rate	115200 bps, 57600 bps, 38400 bps, 19200 bps, 9600 bps, 4800 bps, 2400 bps, 1200 bps, User Define (an arbitrary bit rate from 200 to 10 Mbps with resolution of 0.5 bps)
Analyzable signals	DLM30xx/DLM30xxHD: CH1 to CH4, Logic input, or M1 to M4 DLM50xx/DLM50xxHD: CH1 to CH8, Logic input, or M1 to M8
Data format	Select a data format from the following 8 bit (Non Parity), 7 bit Data + Parity, 8 bit + Parity
UART trigger modes	Every Data, Data, Error
Analyzable no. of data	300000 bytes max.

List display items	Analysis no., Time from trigger position [Time (ms)], Data (Bin, Hex) display, ASCII display, Information.
--------------------	--

CAN Bus Signal Analysis Functions (/F2 or /F02 Option)

Applicable bus	CAN version 2.0A/B, Hi-Speed CAN (ISO11898), Low-Speed CAN (ISO11519-2)
Analyzable signals	DLM30xx/DLM30xxHD: CH1 to CH4, M1 to M4 DLM50xx/DLM50xxHD: CH1 to CH8, M1 to M8
Bit rate	1 Mbps, 500 kbps, 250 kbps, 125 kbps, 83.3 kbps, 33.3 kbps, User Define (an arbitrary bit rate from 10 kbps to 1 Mbps with resolution of 100 bps)
CAN bus trigger modes	SOF, ID/Data, ID OR, Error, Message and signal (enabled when loading physical values/symbol definitions)
Analyzable no. of frames	100000 frames max.
List display items	Analysis no., Time from trigger position [Time (ms)], Frame type, ID, DLC, Data, CRC, Presence/absence of Ack, Information
Auxiliary analysis functions	Field jump functions

CAN FD Bus Signal Analysis Functions (/F2 or /F02 Option)

Applicable bus	CAN FD (ISO 11898-1:2015 and non-ISO)
Analyzable signals	DLM30xx/DLM30xxHD: CH1 to CH4, M1 to M4 DLM50xx/DLM50xxHD: CH1 to CH8, M1 to M8
Bit rate	Arbitration 1 Mbps, 500 kbps, 250 kbps, User Define (an arbitrary bit rate from 20 kbps to 1 Mbps with resolution of 100 bps) Data 8 Mbps, 5 Mbps, 4 Mbps, 2 Mbps, 1 Mbps, 500 kbps, User Define (an arbitrary bit rate from 250 kbps to 10 Mbps with resolution of 100 bps)
CAN FD bus trigger modes	SOF, Error, ID/Data, ID OR, FDF, ESI, Message (enabled when loading physical values/symbol definitions)
Analyzable no. of frames	50000 frames max.
List display items	Analysis no., Time from trigger position [Time (ms)], Frame type, ID, DLC, Data, CRC, Presence/absence of Ack, Information
Auxiliary analysis functions	Field jump functions

LIN Bus Signal Analysis Functions (/F2 or /F02 Option)

Applicable bus	LIN Rev. 1.3, 2.0
Analyzable signals	DLM30xx/DLM30xxHD: CH1 to CH4, M1 to M4 DLM50xx/DLM50xxHD: CH1 to CH8, M1 to M8
Bit rate	19.2 kbps, 9.6 kbps, 4.8 kbps, 2.4 kbps, 1.2 kbps, User Define (an arbitrary bit rate from 1 kbps to 20 kbps with resolution of 10 bps)
LIN bus trigger modes	Break Synch, ID/Data, ID OR, Error
Analyzable no. of frames	100000 frames max.
List display items	Analysis no., Time from trigger position [Time (ms)], ID, ID-Field, Data, Checksum, Information
Auxiliary analysis functions	Field jump functions

FlexRay Bus Signal Analysis Functions (/F3 or /F03 Option)

Applicable bus	FlexRay Protocol Version 2.1
Analyzable signals	DLM30xx/DLM30xxHD: CH1 to CH4, M1 to M4 DLM50xx/DLM50xxHD: CH1 to CH8, M1 to M8
Bit rate	10 Mbps, 5 Mbps, 2.5 Mbps
FlexRay bus trigger modes	Frame Start, Error, ID/Data, ID OR
Analyzable no. of frames	5000 frames max.
List display items	Analysis no., Time from trigger position [Time (ms)], Segment (Static or Dynamic), Indicator, FrameID, Payload length, Cycle count, Data, Information

SENT Signal Analysis Functions (/F4 or /F04 Option)

Applicable standard	J2716 APR2016 and older
Analyzable signals	DLM30xx/DLM30xxHD: CH1 to CH4, Logic input, or M1 to M4 DLM50xx/DLM50xxHD: CH1 to CH8, Logic input, or M1 to M8
Clock period	1 µs to 100 µs with resolution of 0.01 µs
Data type	Fast channel Nibbles/User Defined Slow channel Short/Enhanced
SENT trigger modes	Every Fast CH, Fast CH Status & Communication, Fast CH Data, Every Slow CH, Slow CH ID/Data, Error
Analyzable no. of frames	100000 frames max.
List display items	Fast channel Analysis no., Time from trigger position [Time (ms)], Sync/Cal period, Tick, Status & Comm, Data, CRC, Frame length, Information Slow channel Analysis no., Time from trigger position [Time (ms)], ID, Data, CRC, Information
Auxiliary analysis functions	Trend functions (up to 4 trend waveforms)

CXPI Bus Signal Analysis Functions (/F5 or /F05 Option)

Applicable bus	CXPI JASO D 015-3:2015
Analyzable signals	DLM30xx/DLM30xxHD: CH1 to CH4, M1 to M4 DLM50xx/DLM50xxHD: CH1 to CH8, M1 to M8
Bit rate	19.2 kbps, 9.6 kbps, 4.8 kbps, User Define (an arbitrary bit rate from 4 kbps to 50 kbps with resolution of 10 bps)
Analyzable no. of frames	10000 frames max.
List display items	Analysis no., Time from trigger position [Time (ms)], ID, DLC, W/S, CT, Data, CRC, Error information, Wakeup/Sleep

PSI5 Signal Analysis Functions (/F6 or /F06 Option)

Applicable standard	PSI5 Airbag [®]
Analyzable signals	DLM30xx/DLM30xxHD: CH1 to CH4, M1 to M4 DLM50xx/DLM50xxHD: CH1 to CH8, M1 to M8
Bit rate	189 kbps, 125 kbps, User Define (10.0 k to 1000.0 kbps, with resolution of 0.1 kbps)
PSI5 Airbag Trigger modes	Sync, Start Bit, Data, Frame In Slot, Error
Analyzable no. of frames	400000 frames max.
List display items	Analysis no., Time from trigger position, Time from Sync, Slot no., Data, Parity/CRC, Information
Auxiliary analysis function	Trend functions (up to 4 trend waveforms)

GP-IB (/C1 Option)

Electromechanical specifications	Conforms to IEEE std. 488-1978 (JIS C 1901-1987)
Protocol	Conforms to IEEE std. 488.2-1992

Auxiliary Input

Rear panel I/O signal	External trigger input, External trigger output, GO/NO-GO output*, Video output *For DLM30xx/DLM30xxHD with /C1 option
Probe interface terminal (front panel)	DLM30xx: 4 terminals (4 ch model), 2 terminals (2 ch model) DLM50xx/DLM50xxHD: 8 terminals (8 ch model), 4 terminals (4 ch model) DLM30xxHD: 4 terminals
Probe power terminal	DLM30xx/DLM30xxHD (rear panel): 4 terminals (/P4 option), 2 terminals (/P2 option) DLM50xx/DLM50xxHD (side panel): 8 terminals (/P8 option), 4 terminals (/P4 option)
Synchronous Operation I/O (SYNC)	26-pin half pitch (female) Dedicated synchronous operation cable (701982-01, -02)

Internal Storage (Standard model, /C8 Option)

Capacity	DLM30xx/DLM30xxHD Standard model: Approx. 300 MB, /C8 option: Approx. 60 GB DLM50xx/DLM50xxHD Standard model: Approx. 1.7 GB, /C8 option: Approx. 64 GB
----------	--

Built-in Printer (/B5 Option)

Built-in printer	112 mm wide, monochrome, thermal
------------------	----------------------------------

Synchronous Operation (/SY or /SYN Option)

Connection method	DLM50xx/DLM50xxHD: Use a connection cable (701982) to connect two DLM50xxs or DLM50xxHDs. (Connection is not available between the DLM50xx, DLM30xxHD, and DLM50xxHD.) DLM30xxHD Use a connection cable (701982) to connect two DLM30xxHDs. (Connection is not available between the DLM50xx, DLM30xxHD, and DLM50xxHD.)
-------------------	---

Synchronization items	Measurement start/stop, Sampling clock, Time, Trigger
-----------------------	---

Sampling skew between units (typical value)		
	Connection cable 701982	
Model name	-01	-02
DLM50xx/DLM50xxHD	20.20 ns	27.90 ns
DLM30xxHD	14.90 ns	22.55 ns

Adjustable to within ±50 ps (De-skew)

Skew adjustment between units (De-skew)	
Adjustable sampling skew between units	
DLM50xx/DLM50xxHD:	
Adjustment range: 15.0 ns to 35.0 ns (0.05 ns resolution)	
DLM30xxHD:	
Adjustment range: 10.0 ns to 35.0 ns (0.05 ns resolution)	

USB Peripheral Connection Terminal

Connector	DLM30xx/DLM30xxHD: USB type A connector × 2 (front panel × 1, rear panel × 1)
	DLM50xx/DLM50xxHD: USB type A connector × 2 (front panel × 2)

Electromechanical specifications	USB 2.0 compliant
----------------------------------	-------------------

Supported transfer standards	High Speed, Full Speed, Low Speed
------------------------------	-----------------------------------

Supported devices	USB Printer Class Ver. 1.0 compliant HP (PCL) inkjet printers, USB Mass Storage Class Ver. 1.1 compliant mass storage devices (Usable capacity: 8 TB, Partition format: GPT/MBR, File format: exFAT/FAT 32/FAT 16) *Please contact your local YOKOGAWA sales office for model names of verified devices
-------------------	--

USB-PC Connection Terminal

Connector	USB type B connector × 1
-----------	--------------------------

Electromechanical specifications	USB 3.0 compliant
----------------------------------	-------------------

Supported transfer standards	Super Speed, High Speed, Full Speed
------------------------------	-------------------------------------

Supported class	Mass Storage Class Ver. 1.1 USBTMC-USB488 (USB Test and Measurement Class Ver. 1.0)
-----------------	--

Ethernet

Connector	RJ-45 connector × 1
-----------	---------------------

Transmission methods	Ethernet (1000BASE-T/100BASE-TX/10BASE-T)
----------------------	---

Supported services	Server: FTP, VXI-11, Socket Client: FTP, SMTP, SNMP, LPR, DHCP, DNS
--------------------	--

PTP	Protocol: IEEE1588-2008 (PTPv2) (client only, master feature is available with /CY option)
-----	--

Synchronization accuracy:	±200 ns (typical) when 1000BASE-T is used and an Ethernet switch is not used
---------------------------	--

Synchronization items:	Built-in time, Sampling clock
------------------------	-------------------------------

*PTP is supported only for DLM50xx/DLM30xxHD/DLM50xxHD

General Specifications

Rated supply voltage	100 to 120 VAC/220 to 240 VAC (Automatic switching)
----------------------	---

Rated supply frequency	50 Hz/60 Hz
------------------------	-------------

Maximum power consumption	DLM30xx/DLM30xxHD: 180 VA DLM50xx/DLM50xxHD: 290 VA
---------------------------	--

External dimensions	DLM30xx/DLM30xxHD: 226 (W) × 293 (H) × 193 (D) mm (when printer cover is closed, excluding protrusions)
	DLM50xx/DLM50xxHD: 426 (W) × 266 (H) × 180 (D) mm (when printer cover is closed, excluding protrusions)

Weight	DLM30xx/DLM30xxHD: Approx. 4.2 kg, With no options DLM50xx/DLM50xxHD: Approx. 7.3 kg, With no options
--------	--

Operating temperature range	5°C to 40°C
-----------------------------	-------------

*1: Measured under standard operating conditions after a 30-minute warm-up followed by calibration. Standard operating conditions: Ambient temperature: 23°C±5°C, Ambient humidity: 55±10% RH
Error in supply voltage and frequency: Within 1% of rating
*2: Value in the case of repetitive phenomenon. The frequency bandwidth of a single-shot phenomenon is the smaller of the two values, DC to sampling frequency/2.5 or the frequency bandwidth of the repetitive phenomenon.
*3: When the input to short circuit, acquisition mode is set to Normal, accumulation is OFF, and the probe attenuation is set to 1:1.
*4: The LCD may include a few defective pixels (within 3 ppm over the total number of pixels including RGB).
*5: Support for analysis of ECU synchronization signals and sensor signals.
*6: Input/Output Ratio measured using FFT (dB)
*7: Input/Output Ratio of SDEV on the time axis (dB)

External Dimensions

Unit: mm

DLM3000/DLM3000HD

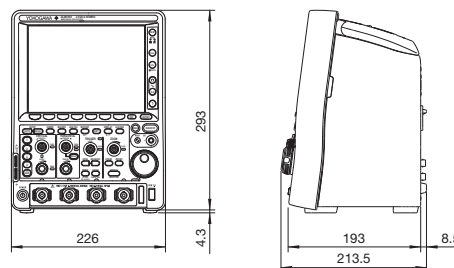

DLM5000/DLM5000HD

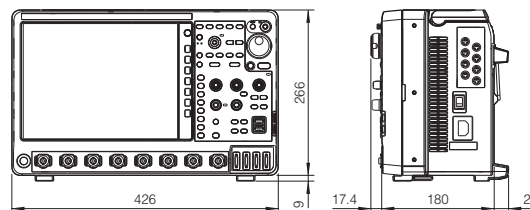

Model and Suffix Codes

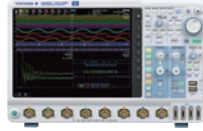

High Definition Oscilloscope DLM5000HD Series

Model ^{1,2}	Suffix Code	Description
DLM5038HD		High Definition Oscilloscope: 8 ch, 350 MHz
DLM5058HD		High Definition Oscilloscope: 8 ch, 500 MHz
DLM5034HD		High Definition Oscilloscope: 4 ch, 350 MHz
DLM5054HD		High Definition Oscilloscope: 4 ch, 500 MHz
Power cord	-D	UL/CSA Standard and PSE compliant
	-F	VDE/Korean Standard
	-Q	British Standard
	-R	Australian Standard
	-H	Chinese Standard
	-N	Brazilian Standard
	-T	Taiwanese Standard
	-B	Indian Standard
	-U	IEC Plug Type B
	Language	-HJ
-HE		English message and panel
-HC		Chinese message and panel
-HG		German message and panel
-HF		French message and panel
-HK		Korean message and panel
-HL		Italian message and panel
-HS		Spanish message and panel
Option	/L4	Expansion logic 16 bit (Total 32 bit)
	/B5	Built-in printer (112 mm)
	/M1 ³	Memory expansion option (8 ch model only) During continuous measurement: 25 M points; Single mode: 125 M points/250 M points ⁴
	/M2 ³	Memory expansion option (8 ch model only) During continuous measurement: 50 M points; Single mode: 250 M points/500 M points ⁴
	/M3 ³	Memory expansion option (8 ch model only) During continuous measurement: 125 M points; Single mode: 500 M points/1 G points ⁴
	/M1S ³	Memory expansion option (4 ch model only) During continuous measurement: 25 M points; Single mode: 125 M points/250 M points ⁴
	/M2S ³	Memory expansion option (4 ch model only) During continuous measurement: 50 M points; Single mode: 250 M points/500 M points ⁴
	/M3S ³	Memory expansion option (4 ch model only) During continuous measurement: 125 M points; Single mode: 500 M points/1 G points ⁴
	/P8 ⁵	8 probe power terminals (for 8 ch model)
	/P4 ⁵	4 probe power terminals (for 4 ch model)
	/C1	GP-IB interface
	/C8	Internal storage (64 GB)
	/CY	IEEE1588 master function
	/SY ⁶	Synchronous Operation
	/G2 ⁷	User-defined math function
	/G3 ⁷	Power supply analysis function
	/GA ⁷	User-defined math function + Power supply analysis function
	/F1	UART + I ² C + SPI trigger and analysis
	/F2	CAN + CAN FD + LIN trigger and analysis
	/F3	FlexRay trigger and analysis
/F4	SENT trigger and analysis	
/F5	CXPI trigger and analysis	
/F6	PSI5 trigger and analysis	
/E1 ⁸	Four additional 701937 probes (8 in total) (for 8 ch model)	
/E2 ⁸	Attach four 701949 probes	
/E3 ⁸	Attach eight 701949 probes (for 8 ch model)	

Standard Main Unit Accessories

Power cord, Passive probe⁹, Protective front cover, Panel sheet⁹, Soft carrying case for probes, Printer roll paper (for /B5 option), Manuals¹⁰

Additional Option License for DLM5000HD

Model	Suffix Code	Description
709823	-CY	IEEE1588 master function
	-SY	Synchronous operation
	-G2	User-defined math function
	-G3	Power supply analysis function
	-F1	UART + I ² C + SPI trigger and analysis
	-F2	CAN + CAN FD + LIN trigger and analysis
	-F3	FlexRay trigger and analysis
	-F4	SENT trigger and analysis
	-F5	CXPI trigger and analysis
	-F6	PSI5 trigger and analysis

High Definition Oscilloscope DLM3000HD series

Model ^{1,2}	Suffix Code	Description
DLM3034HD		High Definition Oscilloscope: 4 ch, 350 MHz
DLM3054HD		High Definition Oscilloscope: 4 ch, 500 MHz
Power cord	-D	UL/CSA Standard and PSE compliant
	-F	VDE/Korean Standard
	-Q	British Standard
	-R	Australian Standard
	-H	Chinese Standard
	-N	Brazilian Standard
	-T	Taiwanese Standard
	-B	Indian Standard
	-U	IEC Plug Type B
	Language	-HJ
-HE		English message and panel
-HC		Chinese message and panel
-HG		German message and panel
-HF		French message and panel
-HK		Korean message and panel
-HL		Italian message and panel
-HS		Spanish message and panel
Option	/LN	No switchable logic input
	/B5	Built-in printer (112 mm)
	/M1 ³	Memory expansion option During continuous measurement: 25 Mpoints; Single mode: 125 Mpoints/250 Mpoints ⁴
	/M2 ³	Memory expansion option During continuous measurement: 50 Mpoints; Single mode: 250 Mpoints/500 Mpoints ⁴
	/M3 ³	Memory expansion option During continuous measurement: 125 Mpoints; Single mode: 500 Mpoints/1 G points ⁴
	/P4 ⁵	4 probe power terminals
	/C1 ¹¹	GP-IB interface + GO/NO-GO terminal
	/SY ^{6,11}	Synchronous Operation
	/C8	Internal storage (60 GB)
	/CY	IEEE1588 master function
	/G2 ¹²	User-defined math function
	/G3 ¹²	Power supply analysis function
	/GA ¹²	User-defined math function + Power supply analysis function
	/F1	UART + I ² C + SPI trigger and analysis
	/F2	CAN + CAN FD + LIN trigger and analysis
	/F3	FlexRay trigger and analysis
	/F4	SENT trigger and analysis
	/F5	CXPI trigger and analysis
	/F6	PSI5 trigger and analysis
	/EX4	Replace all probes with 701949

Standard Main Unit Accessories

Power cord, Passive probe⁹, Protective front cover, Panel sheet⁹, Soft carrying case for probes, Printer roll paper (for /B5 option), User's manuals¹⁰

- *1: Standard memory capacity: During continuous measurement: 12.5 M points; Single mode: 50 M points/125 M points (when odd channels only)
- *2: Logic probes sold separately. Please order the model 701988/701989 accessory logic probes separately.
- *3, *7, *11, *12: When selecting from these options, please select only one.
- *4: When odd channels only
- *5: Specify this option when using current probes or other differential probes that don't support probe interface.
- *6: This option for both main and sub unit and a 701982 connection cable are required for synchronous operation.
- *8: Four 701937 except /E2 or /E3.
- *9: Except suffix code "-HE".
- *10: Start guide as the printed material, and User's manual can be downloaded from our web page.
- *13: 701937, per number of channels. When /EX4 option is selected, no 701937 is included.

Additional Option License for DLM3000HD

Model	Suffix Code	Description
709813	-CY	IEEE1588 master function
	-G2	User-defined math function
	-G3	Power supply analysis function
	-F1	UART + I ² C + SPI trigger and analysis
	-F2	CAN + CAN FD + LIN trigger and analysis
	-F3	FlexRay trigger and analysis
	-F4	SENT trigger and analysis
	-F5	CXPI trigger and analysis
	-F6	PSI5 trigger and analysis

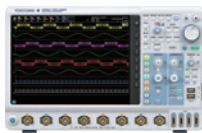

Mixed Signal Oscilloscope DLM5000 series

Model ^{1,2}	Suffix Code	Description
DLM5038		Mixed Signal Oscilloscope: 8 ch, 350 MHz
DLM5058		Mixed Signal Oscilloscope: 8 ch, 500 MHz
DLM5034		Mixed Signal Oscilloscope: 4 ch, 350 MHz
DLM5054		Mixed Signal Oscilloscope: 4 ch, 500 MHz
Power cord	-D	UL/CSA Standard and PSE compliant
	-F	VDE/Korean Standard
	-Q	British Standard
	-R	Australian Standard
	-H	Chinese Standard
	-N	Brazilian Standard
	-T	Taiwanese Standard
	-B	Indian Standard
Language	-U	IEC Plug Type B
	-HJ	Japanese message and panel
	-HE	English message and panel
	-HC	Chinese message and panel
	-HG	German message and panel
	-HF	French message and panel
	-HK	Korean message and panel
	-HL	Italian message and panel
Option	-HS	Spanish message and panel
	/L32	Expansion logic 16 bit (Total 32 bit)
	/B5	Built-in printer (112 mm)
	/M1 ³	Memory expansion option (8 ch model only) During continuous measurement: 25 M points; Single mode: 125 M points/250 M points ⁴
	/M2 ³	Memory expansion option (8 ch model only) During continuous measurement: 50 M points; Single mode: 250 M points/500 M points ⁴
	/M1S ³	Memory expansion option (4 ch model only) During continuous measurement: 25 M points; Single mode: 125 M points/250 M points ⁴
	/M2S ³	Memory expansion option (4 ch model only) During continuous measurement: 50 M points; Single mode: 250 M points/500 M points ⁴
	/P8 ⁵	8 probe power terminals (for 8 ch model)
	/P4 ⁵	4 probe power terminals (for 4 ch model)
	/C1	GP-IB interface
	/C8	Internal storage (64 GB)
	/SYN ⁶	Synchronous Operation
	/G02	User-defined math function
	/G03	Power supply analysis function
	/F01	UART + I ² C + SPI trigger and analysis
	/F02	CAN + CAN FD + LIN trigger and analysis
	/F03	FlexRay trigger and analysis
/F04	SENT trigger and analysis	
/F05	CXPI trigger and analysis	
/F06	PSI5 trigger and analysis	
/E1 ⁷	Four additional 701937 probes (8 in total) (for 8 ch model)	
/E2 ⁷	Attach four 701949 probes	
/E3 ⁷	Attach eight 701949 probes (for 8 ch model)	

Standard Main Unit Accessories

Power cord, Passive probe⁸, Protective front cover, Panel sheet⁹, Soft carrying case for probes, Printer roll paper (for /B5 option), User's manuals¹⁰

Additional Option License for DLM5000

Model	Suffix Code	Description
709821	-G02	User defined math
	-G03	Power supply analysis function
	-F01	UART + I ² C + SPI trigger and analysis
	-F02	CAN + CAN FD + LIN trigger and analysis
	-F03	FlexRay trigger and analysis
	-F04	SENT trigger and analysis
	-F05	CXPI trigger and analysis
	-F06	PSI5 trigger and analysis
	-SYN	Synchronous Operation



Mixed Signal Oscilloscope DLM3000 series

Model ¹	Suffix Code	Description
DLM3022		Digital Oscilloscope: 2 ch, 200 MHz
DLM3024 ²		Mixed Signal Oscilloscope: 4 ch, 200 MHz
DLM3032		Digital Oscilloscope: 2 ch, 350 MHz
DLM3034 ²		Mixed Signal Oscilloscope: 4 ch, 350 MHz
DLM3052		Digital Oscilloscope: 2 ch, 500 MHz
DLM3054 ²		Mixed Signal Oscilloscope: 4 ch, 500 MHz
Power cord	-D	UL/CSA Standard and PSE compliant
	-F	VDE/Korean Standard
	-Q	British Standard
	-R	Australian Standard
	-H	Chinese Standard
	-N	Brazilian Standard
	-T	Taiwanese Standard
	-B	Indian Standard
Language	-U	IEC Plug Type B
	-HJ	Japanese message and panel
	-HE	English message and panel
	-HC	Chinese message and panel
	-HG	German message and panel
	-HF	French message and panel
	-HK	Korean message and panel
	-HL	Italian message and panel
Option	-HS	Spanish message and panel
	/LN	No switchable logic input (4 ch model only)
	/B5	Built-in printer (112 mm)
	/M1 ³	Memory expansion option (4 ch model only) During continuous measurement: 25 Mpoints; Single mode: 125 Mpoints/250 Mpoints ⁴
	/M2 ³	Memory expansion option (4 ch model only) During continuous measurement: 50 Mpoints; Single mode: 250 Mpoints/500 Mpoints ⁴
	/P2 ⁵	2 probe power terminals (for 2 ch model)
	/P4 ⁵	4 probe power terminals (for 4 ch model)
	/C1	GP-IB interface + GO/NO-GO terminal
	/C8	Internal storage (60 GB)
	/G02	User-defined math function (4 ch model only)
	/G03	Power supply analysis function (4 ch model only)
	/F01	UART + I ² C + SPI trigger and analysis (4 ch model only)
	/F02	CAN + CAN FD + LIN trigger and analysis (4 ch model only)
	/F03	FlexRay trigger and analysis (4 ch model only)
	/F04	SENT trigger and analysis (4 ch model only)
	/F05	CXPI trigger and analysis (4 ch model only)
	/F06	PSI5 trigger and analysis (4 ch model only)
/EX2 ¹¹	Replace all probes with 701949 (2 ch model only)	
/EX4 ¹¹	Replace all probes with 701949 (4 ch model only)	

Standard Main Unit Accessories

Power cord, Passive probe¹¹, Protective front cover, Panel sheet⁹, Soft carrying case for probes, Printer roll paper (for /B5 option), User's manuals¹⁰

¹: Standard memory capacity: During continuous measurement: 12.5 M points; Single mode: 50 M points/125 M points (when odd channels only)

²: Logic probes sold separately. Please order the model 701988/701989 accessory logic probes separately.

³, ⁷:

When selecting from these options, please select only one.

⁴: When odd channels only

⁵: Specify this option when using current probes or other differential probes that don't support probe interface.

⁶: This option for both main and sub unit and a 701982 connection cable are required for synchronous operation.

⁸: Four 701937 except /E2 or /E3.

⁹: Except suffix code "-HE".

¹⁰: Start guide as the printed material, and User's manual can be downloaded from our web page.

¹¹: 701937, per number of channels. When either /EX2 or /EX4 option is selected, no 701937 is included.

Additional Option License for DLM3000 (4 ch model only)

Model	Suffix Code	Description
709811	-G02	User defined math
	-G03	Power supply analysis function
	-F01	UART + I ² C + SPI trigger and analysis
	-F02	CAN + CAN FD + LIN trigger and analysis
	-F03	FlexRay trigger and analysis
	-F04	SENT trigger and analysis
	-F05	CXPI trigger and analysis
	-F06	PSI5 trigger and analysis

Accessory Models

Model	Name	Specification	
701988	Logic probe (PBL100)	1 M Ω , toggle freq. of 100 MHz	
701989	Logic probe (PBL250)	100 k Ω , toggle freq. of 250 MHz	
701937	Passive probe ¹	10 M Ω (10:1), 500 MHz, 1.3 m	
701949	Miniature passive probe	10 M Ω (10:1), 500 MHz, 1.3 m	
702907	Passive probe (Wide temperature range)	10 M Ω (10:1), 200 MHz, 2.5 m -40°C to +85°C	
700939	FET probe ¹	DC to 900 MHz BW, 2.5 M Ω /1.8 pF	
701944	100:1 voltage probe	DC to 400 MHz BW, 1.2 m, 1000 Vrms	
701945	100:1 voltage probe	DC to 250 MHz BW, 3 m, 1000 Vrms	
701977	Differential probe	DC to 50 MHz BW, max. \pm 7000 V	
701978	Differential probe	DC to 150 MHz BW, max. \pm 1500 V	
701924	Differential probe (PBDH1000)	DC to 1 GHz BW, 1 M Ω , max. \pm 25 V	
701925	Differential probe (PBDH0500)	DC to 500 MHz BW, max. \pm 25 V	
701927	Differential probe (PBDH0150)	DC to 150 MHz BW, max. \pm 1400 V	
701917	Current probe ²	DC to 50 MHz BW, 5 Arms	
701918	Current probe ²	DC to 120 MHz BW, 5 Arms	
701929	Current probe (PBC050) ²	DC to 50 MHz BW, 30 Arms	
701928	Current probe (PBC100) ²	DC to 100 MHz BW, 30 Arms	
701930	Current probe ²	DC to 10 MHz BW, 150 Arms	
701931	Current probe ²	DC to 2 MHz BW, 500 Arms	
702915	Current probe ²	DC to 50 MHz BW, 0.5, 5, 30 Arms	
702916	Current probe ²	DC to 120 MHz BW, 0.5, 5, 30 Arms	

Model	Name	Specification	
701936	Deskew correction signal source	For deskew correction	
366973	Go/No-Go Cable	For GO/NO-GO output terminal	
B9988AE	Printer roll paper	Lot size is 10 rolls, 10 meters each	
701919	Probe stand	Round base, 1 arm	
701968	Soft carrying case	For DLM5000HD/DLM5000 with 3 pockets for storage	
701964	Soft carrying case	For DLM3000HD/DLM3000 with 3 pockets for storage	
701969-E	Rack mount kit	For DLM5000HD/DLM5000 (EIA standard compliant)	
701969-J	Rack mount kit	For DLM5000HD/DLM5000 (JIS standard compliant)	
701982-01	Connection cable	Connection cable for DLM 1.0 m	
701982-02	Connection cable	Connection cable for DLM 2.8 m	
701934	Probe power supply	A power supply for current probes, FET probes, and differential probes. Provides power for up to four probes, including large current probes.	
/Px option*	Probe power option	Built-in probe power terminals on the main unit can be used to power current probes, FET probes, and differential probes (/P2, /P4 and /P8 option).	

*1: Please refer to the Probes and Accessories brochure for probe adapters.

*2: Current probes' maximum input current may be limited by the number of probes used at a time.

Accessory Software

Model	Name	Specification
IS8001*	IS8000 Integrated Software	Subscription (Annual license)
IS8002*	Platform	Perpetual (Permanent license)
IS8002CDV	Classic Data Viewer	Perpetual (Permanent license)

*The Classic Data Viewer is available free of charge for the duration of the purchased IS8001/IS8002 license.

*The IS8002CDV will support DLM3000HD soon.

*See Bulletin IS8000-01EN for more details about the IS8000.

[DLM is a registered trademark of Yokogawa Electric Corporation.]

Any company's names and product names appearing in this document are the registered trademarks or trademarks of their respective companies.

NOTICE

- Before operating the product, read the user's manual thoroughly for proper and safe operation.

This is a Class A instrument based on Emission standards EN61326-1 and EN55011, and is designed for an industrial environment. Operation of this equipment in a residential area may cause radio interference, in which case users will be responsible for any interference which they cause.

YOKOGAWA

YOKOGAWA TEST & MEASUREMENT CORPORATION
Global Sales Dept. /E-mail: tm@cs.jp.yokogawa.com

<https://tmi.yokogawa.com/>

YMI-N-MI-M-E03

The contents are as of September, 2024 Subject to change without notice.
Copyright © 2024, Yokogawa Test & Measurement Corporation
[Ed: 01/b] Printed in Japan, 409(KP)

Thurlby Thandar Instrument Distribution
Glebe Road, Huntingdon, PE29 7DR, UK
+44 (0)1480 412 451
sales@ttid.co.uk
www.ttid.co.uk

